

STIHL E 220

**Instruction Manual
Owner's Manual**

**Assembling
Safety Precautions
Operating Instructions
Maintenance**



Warning!
Read and follow all safety
precautions in Owner's Manual
– improper use can cause
serious or fatal injury.

To reduce risk of kickback injury use
STIHL reduced kickback bar and
STIHL RM 2 (3/8") chain or other
available low kickback components.

© Andreas Stihl 1985.

Important Safety Precautions for Chain Saw Users

A. Kickback Safety Precautions

Warning!

Kickback may occur when the nose or tip of the guide bar touches an object, or when the wood closes in and pinches the saw chain in the cut. Tip contact in some cases may cause a lightning fast reverse reaction, kicking the guide bar up and back towards the operator.

Pinching the saw chain along the top of the guide bar may push the guide bar rapidly back towards the operator. Either of these reactions may cause you to lose control of the saw which could result in serious personal injury.

Section 5.12 of ANSI B 175.1-2000 sets certain performance and design criteria related to chainsaw kickback. STIHL has developed a color code system using green and yellow to help you select a powerhead, bar and chain combination that complies with the kickback requirements of the ANSI Standard. See the sections entitled "Safety Precautions" and "Specifications" of this manual.

Do not rely exclusively upon the safety devices built into your saw. As a chainsaw user, you should take several steps to keep your cutting jobs free from accident or injury.

1. With a basic understanding of kickback, you can reduce or eliminate the element of surprise. Sudden surprise contributes to accidents.
2. Keep a good firm grip on the saw with both hands, the right hand on the rear handle, and the left hand on the front handle, when the engine is running. Use a firm grip with thumbs and fingers encircling the chainsaw handles. A firm grip will help you reduce kickback and maintain control of the saw. Don't let go.
3. Make sure the area in which you are cutting is free from obstructions. Do not let the nose of the guide bar contact a log, branch, or any other obstruction while you are operating the saw.
4. Cut at high engine speeds.
5. Do not overreach or cut above shoulder height.

6. Follow manufacturer's sharpening and maintenance instructions for the saw chain.
7. Only use replacement bars and chains specified by the manufacturer or the equivalent.

B. Other Safety Precautions

1. Do **not** operate a chainsaw with one hand! Serious injury to the operator, helpers, bystanders, or any combination of these persons may result from one-handed operation. A chainsaw is intended to be used with two hands.
2. Do not operate a chainsaw when you are fatigued.
3. Use safety footwear; snug-fitting clothing; protective gloves; and eye, hearing, and head protection devices.
4. Do not allow other persons to be near the chainsaw when starting or cutting with the chainsaw. Keep bystanders and animals out of the work area.

continued on the back inside cover



Contents

Main Parts and Controls	2	Maintaining and Sharpening	31
Definitions	3	the Saw Chain	34
Safety Precautions	4	Maintenance Chart	35
Mounting the Bar and Chain	23	Specifications	36
Tensioning the Saw Chain	24	Ordering Spare Parts	36
Checking Chain Tension	24	Addresses	36
Chain Oil	24		
Filling Chain Oil Tank	25		
Chain Brake	25		
Connecting Saw to Power Supply	26		
Switching On	26		
Switching Off	26		
Overload Circuit Breaker	27		
Checking Chain Lubrication	27		
During Operation	28		
After Finishing Work	28		
Taking Care of Guide Bar	28		
Checking and Replacing			
the Chain Sprocket	29		
Motor Cooling	30		
Storing the Machine	30		

This manual contains operating and safety instructions for all STIHL E 220 series chainsaws. Pay special attention to the safety precautions outlined on pages 4 to 20. Allow only persons who understand this Manual to operate your chainsaw. To receive maximum performance and satisfaction from your STIHL chainsaw, it is important that you read and understand the maintenance and safety precautions before using your saw. Contact your STIHL dealer or the STIHL distributor for your area if you do not understand any of the instructions in this Manual.

Warning!

Because a chainsaw is a high-speed wood-cutting tool, some special safety precautions must be observed as with any other power saw to reduce the risk of personal injury. Careless or improper use may cause serious or even fatal injury. STIHL's philosophy is to continually improve all of its products. As a result, engineering changes and improvements are made from time-to-time. If the operating characteristics or the appearance of your saw differ from those described in this Manual, please contact your STIHL dealer for information and assistance.

Printed on chlorine-free paper

Printing inks contain vegetable oils,
paper is recyclable

© 2002 Andreas Stihl AG & Co., Waiblingen
0458 107 3021. M0,75, B2. Rel. Printed in Germany

E 220

STIHL®

Main Parts and Controls

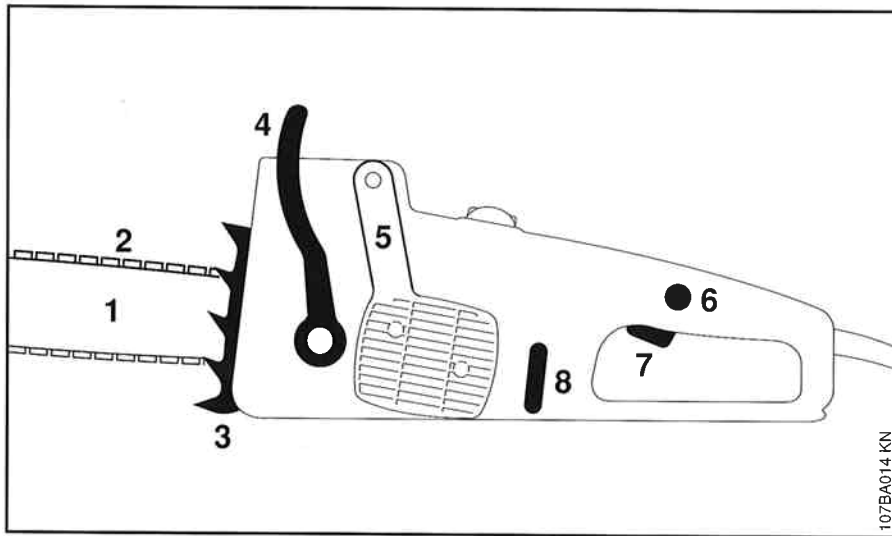

- 1 = E-matic guide bar
- 2 = Oilomatic saw chain
- 3 = Bumper spike
- 4 = Front hand guard
- 5 = Front handle
- 6 = Interlock button
- 7 = Trigger switch
- 8 = Oil inspection window

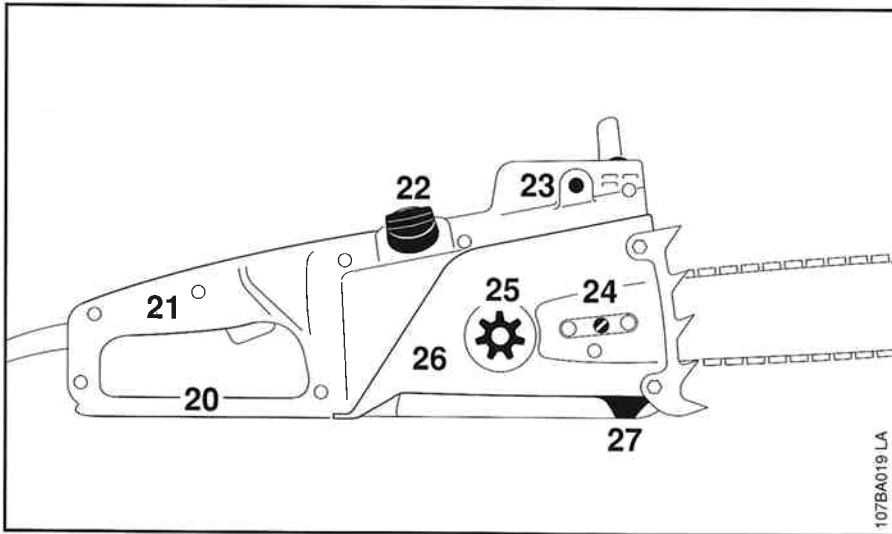

- 20 = Rear hand guard
- 21 = Rear handle
- 22 = Oil filler cap
- 23 = Overload circuit breaker
- 24 = Side chain tensioner
- 25 = Chain sprocket
- 26 = Chain sprocket cover
- 27 = Chain catcher

Definitions

1. **Ematic Guide Bar**
Supports and guides the saw chain.
 2. **Oilomatic Saw Chain**
A loop consisting of cutters, tie straps and drive links.
 3. **Bumper Spike**
Toothed stop for holding saw steady against wood.
 4. **Front Hand Guard**
Provides protection against projecting branches and helps prevent left hand from touching the chain if it slips off the handle bar.
 5. **Front Handle**
Handle bar for the left hand at front of saw.
 6. **Interlock button**
Must be depressed before the trigger switch can be activated.
 7. **Trigger Switch**
Controls the speed of the motor.
 8. **Oil Inspection Window**
For visually checking the oil level.
 20. **Rear Hand Guard**
Gives added protection to operator's right hand.
 21. **Rear Handle**
The support handle for the right hand, located at or toward the rear of the saw.
 22. **Oil Filler Cap**
For closing the oil tank.
 23. **Overload Circuit Breaker**
Interrupts power supply when excessive infeed force is used or when chain becomes pinched in cut. Motor stops.
 24. **Side Chain Tensioner**
Permits precise adjustment of chain tension.
 25. **Chain Sprocket**
The toothed wheel that drives the saw chain.
 26. **Chain Sprocket Cover**
Covers the clutch and the sprocket.
 27. **Chain Catcher**
Helps to reduce the risk of operator contact by a chain if it breaks or comes off the bar.
- Guide Bar Nose**
The exposed end of the guide bar. (not illustrated, see chapter "Mounting the Bar and Chain").
- Chain Guard (Scabbard)**
To protect the operator from touching the chain (not illustrated).

SAFETY PRECAUTIONS



The use of any chainsaw may be hazardous. The saw chain has many sharp cutters. If the cutters contact your flesh, they will cut you, even if

the chain is not moving. At full throttle, the chain speed can reach 45 mph (20 m/s). It is important that you read, fully understand and observe the following safety precautions and warnings. Read the Owner's Manual and the Safety Precautions periodically.

Pay special attention to the section on reactive forces.

Warning!

Reactive forces, including kickback, can be dangerous. Careless or improper use of any chainsaw may cause serious or fatal injury.

All safety precautions that are generally observed when working with an axe or a hand saw also apply to the operation of chainsaws. However, because a chainsaw is a high-speed, fast-cutting power tool, special safety precautions must be observed to reduce the risk of personal injury.

Have your STIHL dealer show you how to operate your chainsaw. Observe all applicable local safety regulations, standards and ordinances.

Warning!

Minors should never be allowed to use a chainsaw. Bystanders, especially children, and animals should not be allowed in the area where a chainsaw is in use. Store it in a locked place away from children. Do not let bystanders contact chain saw or extension cord.



Do not lend or rent your chainsaw without the Owner's Manual. Be sure that anyone using your saw reads and understands the

information contained in this manual.

These safety precautions and warnings apply to the use of all STIHL chainsaws. Different models may have different parts and controls. See the appropriate section of your Owner's Manual for a description of the controls and function of the parts of your model saw.

Safe use of a chainsaw involves

1. the operator
2. the saw
3. the use of the saw.

THE OPERATOR

Physical Condition

You must be in good physical condition and mental health and not under the influence of any substance (drugs, alcohol) which might impair vision, dexterity or judgement.

Do not operate a chainsaw when you are fatigued. Be alert - If you get tired while operating your chainsaw, take a break. Tiredness may result in loss of control. Working with any chainsaw can be strenuous. If you have any condition that might be aggravated by strenuous work, check with your doctor before operating a chainsaw.

Warning!

Prolonged use of chainsaws (or other machines) exposing the operator to vibrations may produce whitefinger disease (Raynaud's phenomenon) or carpal tunnel syndrome.

These conditions reduce the hand's ability to feel and regulate temperature, produce numbness and burning sensations and may cause nerve and circulation damage and tissue necrosis.

All factors which contribute to whitefinger disease are not known, but cold weather, smoking and diseases or physical conditions that affect blood vessels and blood transport, as well as high vibration levels and long periods of exposure to vibration are mentioned as factors in the development of whitefinger disease. In order to reduce the risk of whitefinger disease and carpal tunnel syndrome, please note the following:

- Wear gloves and keep your hands warm.
- Keep the saw chain sharp and the saw well maintained. A dull chain will increase cutting time, and pressing a dull chain through wood will increase the vibrations transmitted to your hands. A saw with loose components will also tend to have higher vibration levels.
- Maintain a firm grip at all times, but do not squeeze the handles with constant, excessive pressures. Take frequent breaks.

All the above mentioned precautions do not guarantee that you will not sustain whitefinger disease or carpal tunnel syndrome. Therefore, continual and regular users should monitor closely the condition of their hands and fingers. If any of the above symptoms appear, seek medical advice immediately.

 **Warning!**

According to STIHL's current knowledge, the electric motor or this unit should not interfere with a pacemaker. When in doubt, however, consult their physician and the pacemaker manufacturer before operating this tool.

Proper Clothing

 **Warning!**

To reduce the risk of injury, the operator should wear proper protective apparel.



Clothing must be sturdy and snug-fitting, but allow complete freedom of movement. Avoid loose-fitting jackets, scarfs, neckties, jewelry, flared or cuffed pants, unconfined long hair or anything that could become entangled with the saw or brush. Wear overalls or jeans with a reinforced cut retardant insert or cut retardant chaps.



Protect your hands with gloves when handling saw and saw chain. Heavy-duty, nonslip gloves improve your grip and protect your hands.



Good footing is most important in chainsaw work. Wear sturdy boots with nonslip soles. Steel-toed safety boots are recommended.

Never operate a chainsaw unless wearing goggles or properly fitted safety glasses with adequate top and side protection complying with your national standard.



Wear an approved safety hard hat to protect your head. Chainsaw noise may damage your hearing. Always wear sound barriers (ear plugs or ear muffers) to protect your hearing. Continual and regular users should have their hearing checked regularly.

THE SAW

Parts of the chainsaw; for illustrations and definitions of the parts see the chapter on "Main Parts of Saw".

Warning!

Never modify a chainsaw in any way. Only attachments and parts supplied by STIHL or expressly approved by STIHL for use with the specific STIHL saw models are authorized. Although certain unauthorized attachments are usable with the STIHL powerhead, their use may, in fact, be extremely dangerous.

THE USE OF THE SAW

Transporting the chainsaw

Warning!

Always fully release the trigger switch and make sure the chain has stopped moving before putting the saw down or carrying it. When carrying the saw over longer distances, disconnect the plug and reposition the extension cord.

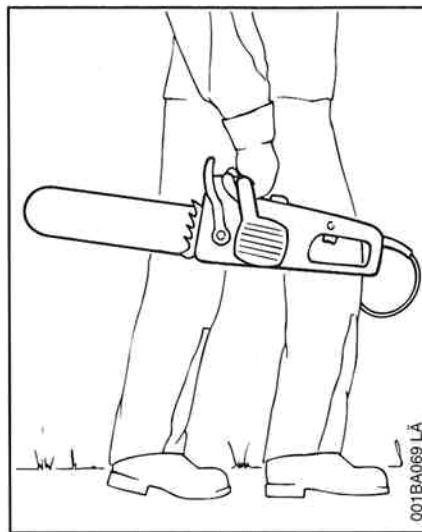

By hand: When carrying the chain saw by hand, it must be switched off and the saw held in the proper position, i.e. it should be gripped by the front handle. The chain guard must be fitted, even when carrying the saw only a short distance, and the guide bar must point backwards, away from the direction in which you are going.

Do not carry the machine by the power cable. Carry the cable in your hand. If the cable is dragged on a rough surface (concrete etc.) the cable may become damaged.

By vehicle: The chain guard must be fitted on the guide bar when transporting the saw in a vehicle. The saw should be secured so that it cannot move and become damaged, or cause damage.

Preparation for the use of the saw

Always disconnect the plug when the saw is not in use. Take off the chain guard and inspect for safety in operation. Insure that the trigger switch will not engage when the trigger interlock is not pressed. For assembly, follow the procedure described in the chapter "Mounting the Bar and Chain" of your Owner's Manual.

STIHL Oilomatic chain, guide bar and sprocket must match each other in gauge and pitch. Before replacing any bar and chain, see the sections on "Specifications", "Kickback" and the "ANSI B 175.1-2000 chainsaw kickback standard" in this manual.

⚠ Warning!

Proper tension of the chain is extremely important. In order to avoid improper setting, the tensioning procedure must be followed as described in your manual. Always make sure the hexagonal nut(s) for the sprocket cover is (are) tightened securely after tensioning the chain. Never start the saw with the sprocket cover loose. Check chain tension once more after having tightened the nut(s) and thereafter at regular intervals (whenever the saw is shut off). If the chain becomes loose while cutting, shut off the motor and then tighten. Never try to adjust the chain while the motor is running!

⚠ Warning!

After adjusting a chain, start the saw, let the motor run for a while, then switch motor off and recheck chain tension. Proper chain tension is very important at all times.

Electric Precautions

Special precautions for electric saws must be observed to reduce the risk of personal injury and property damage from fire and electric shock.

This electric chain saw is double insulated.

⚠ Warning!

To reduce risk of serious or fatal injury from electrocution, never use your machine if casing around motor is cracked or damaged.

⚠ Warning!

The electrical power voltage must agree with the voltage specified on the saw's name plate. Improper voltage may cause the motor to overheat, which will damage the saw and may cause personal injury.

⚠ Warning!



To reduce the risk of electrocution never work in rain or wet places - the electric motor is not waterproof! Do not leave the chain saw outdoors in

the rain and do not operate it if it shows any signs of dampness.

⚠ Warning!

To reduce the risk of personal injury from fire and explosion, do not use the saw in the presence of flammable liquids or gases. The sparks from an electric saw may be a source of ignition!

⚠ Warning!



Inspect the power cable before and after each use for signs of damage or aging. In order to reduce the risk of serious or fatal injury from electrocution,

never use your machine if the power cable is cut, cracked, worn or damaged. Turn off power at saw, disconnect the plug immediately and have dealer replace such a cable.

Avoid damage to the power cable. Keep it away from heat, oil and sharp edges. Never jerk power cable to disconnect the plug from the wall outlet. To unplug, grasp the plug, not the cable.

Extension cords

⚠ Warning!

To reduce the risk of electric shock, use only extension cords that are intended for outdoor use. These extension cords are identified by a marking „Acceptable for use with outdoor appliances; store indoors while not in use.“

Do not use damaged extension cords. Examine extension cord before using and replace if damaged. Do not abuse extension cord and do not yank on any cord to disconnect. To unplug, grasp the plug, not the cord. Keep cord away from heat, oil and sharp edges.

If you use an extension cord, be sure to use one heavy enough to carry the current your electric saw will draw. An improper gauged extension cord will cause a drop in wire voltage resulting in loss of power and overheating. Use only extension cords having an electrical rating not less than the rating of the product.

The following table shows the correct size to use depending on cord length and machine label ampere rating.

Minimum wire size for extension cords for 120 Volt appliances:

Cord types: SJW-A or SJTW-A
Round jacketed cords.

Using not more than 12 amps			
Cord length (ft)	50	100	150
Wire size (AWG)	14	12	10

Using not more than 15 amps			
Cord length (ft)	50	100	150
Wire size (AWG)	10	*	*

* not recommended

Listed by UL, W-A marking on cable jacket indicates "use outdoors".
Appropriate extension cords are available in stores specializing in electrical equipment.

To reduce the risk of electric shock, this appliance has a polarized plug (one blade is wider than the other). This plug will fit in a polarized outlet only one way. If the plug does not fit fully in the outlet, reverse the plug. If it still does not fit, contact a qualified electrician to install the proper outlet. Do not change the plug in any way.

⚠ Warning!

Position the electric cable so that it will not be damaged when using the electric saw. Always keep the electric cable behind the operator and away from the bar and chain. Always be sure that your cable does not become entangled with obstacles or objects. Damaged cables may cause electrocution. If you take a break at your work, always disconnect the cable.

Working Conditions

Operate the chainsaw under good visibility and daylight conditions only.

⚠ Warning!

Your saw is a one person saw. Do not allow other persons to be near the running chain saw. Operate your saw without assistance.

⚠ Warning!

Be sure that the guide bar and chain are clear of you and all other obstructions and objects, including the ground. If the bar nose near the upper quadrant touches an object, it may cause kickback to occur (see section on reactive forces). Never attempt to start the chainsaw when the guide bar is in a cut or kerf.

⚠ Warning!

Use of this product (including sharpening the saw chain) can generate dust, mists and fumes containing chemicals known to cause respiratory disease, cancer, birth defects, or other reproductive harm. If you are unfamiliar with the risks associated with the particular dust, mist or fume at issue, consult your employer, governmental agencies such as OSHA and NIOSH and other sources on hazardous materials. California and some other authorities, for instance, have published lists of substances known to cause cancer, reproductive toxicity, etc. Control dust (such as sawdust), mists (such as oil mist from chain lubrication) and fumes at the source where possible.

In this regard use good work practices and follow the recommendations of OSHA / NIOSH and occupational and trade associations. When the inhalation of toxic dust, mists and fumes cannot be eliminated, the operator and any bystanders should always wear a respirator approved by NIOSH / MSHA for the type substance at issue.

⚠ Warning!

Breathing asbestos dust is dangerous and can cause severe or fatal injury, respiratory illness or cancer. The use and disposal of asbestos containing products have been strictly regulated by OSHA and the Environmental Protection Agency. Do not cut or disturb asbestos, asbestos containing products (e.g. asbestos containing drywall or other construction products), or products such as pipes which are wrapped or covered with asbestos insulation. If you have any reason to believe that you might be cutting asbestos, immediately contact your employer or a local OSHA representative.

Don't work alone. Keep within calling distance of others in case help is needed.

Your chainsaw is equipped with a chain catcher. It is designed to reduce the risk of personal injury in the event of a thrown or broken chain. From time to time the catcher may be damaged or removed.

To reduce the risk of personal injury, do not operate a chainsaw with a damaged or missing catcher.

⚠ Warning!

Avoid stumbling on obstacles such as stumps, roots or rocks and watch out for holes or ditches. Clear the area where you are working. Be extremely cautious when working on slopes or uneven ground. There is increased danger of slipping on freshly debarked logs.

⚠ Warning!



To reduce the risk of serious or fatal injury to the operator or bystanders, never use the saw with one hand.

You cannot control reactive forces and you may lose control of the saw, which can result in the skating or bouncing of the bar and chain along the limb or log.

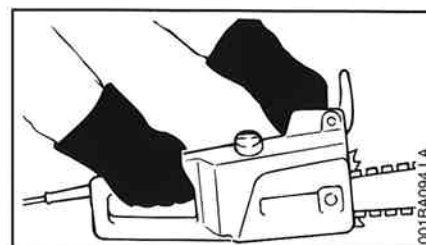

Cutting Instructions

Grip: Always hold the saw firmly with both hands when the engine is running. Place your left hand on front handle bar and your right hand on rear handle and throttle trigger. Left-handers should follow these instructions too.

Wrap your fingers tightly around the handles, keeping the handles cradled between your thumb and forefinger. With your hands in this position, you can best oppose and absorb the push, pull and kickback forces of your saw without losing control (see section on reactive forces). Make sure your chainsaw handles and grip are in good condition and free of moisture, pitch, oil or grease.

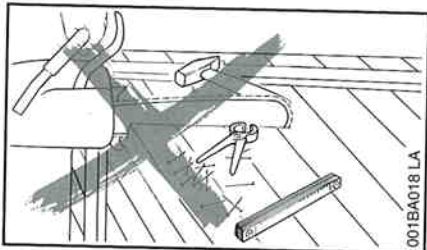

⚠ Warning!

Never touch a chain with your hand or any part of your body when the engine is running, even when the chain is not rotating. The chain continues to rotate for a short period after the throttle trigger is released.

⚠ Warning!

Do not cut any material other than wood or wooden objects. Use your chain sawing only. It is not designed for prying or shoveling away limbs, roots or other objects. When sawing, make sure that the saw chain does not touch any foreign materials such as rocks, fences, nails and the like. Such objects may be flung off, damage the saw chain or cause the saw to kickback.

⚠ Warning!

In order to keep control of your saw, always maintain a firm foothold.

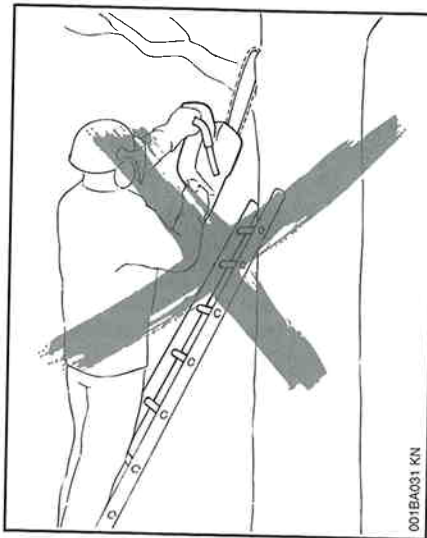

Never work on a ladder, or on any other insecure support. Never use the saw above shoulder height.

⚠ Warning!

Never work in a tree unless you have received specific, professional training for such work, are properly secured (such as tackle and harness system or a lift bucket), have both hands free for operating the chainsaw in a cramped environment and have taken proper precautions to avoid injury from falling limbs or branches.

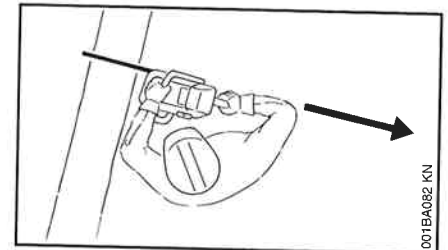

Position the chainsaw in such a way that your body is clear of the cutting attachment whenever the engine is running. Stand to the left of cut while bucking.

Don't put pressure on the saw when reaching the end of a cut. The pressure may cause the bar and rotating chain to pop out of the cut or kerf, go out of control and strike the operator or some other object. If the rotating chain strikes some other object, a reactive force may cause the moving chain to strike the operator.

Reactive forces including kickback

⚠ Warning!

Reactive forces may occur any time the chain is rotating. Reactive forces can be dangerous! In any chainsaw,



001BA093 LA

the powerful force used to cut wood can be reversed (and work against the operator). If the rotating chain is suddenly stopped by contact with any solid object like a log or branch or is pinched, the reactive forces may occur instantly. These reactive forces may result in loss of control which may, in turn, cause serious or fatal injury. An understanding of the causes of these reactive forces may help you avoid loss of control.

The most common reactive forces are

- kickback,
- pushback,
- pull-in.

Kickback:



Kickback may occur when the moving saw chain near the upper quadrant of the bar nose contacts a solid object or is pinched.

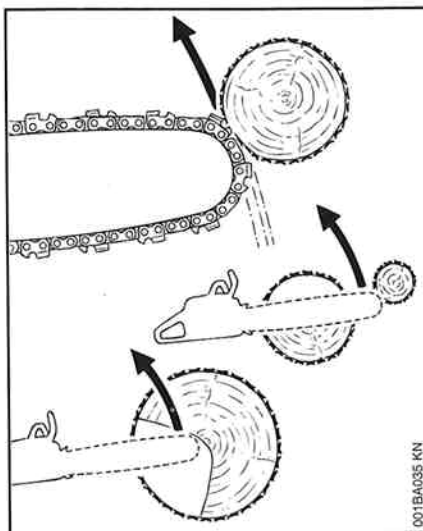

001BA035 KN

The reaction of the cutting force of the chain causes a rotational force on the chainsaw in the direction opposite to the chain movement. This may fling the bar up and back in an uncontrolled arc mainly in the plane of the bar. Under some cutting circumstances the bar moves towards the operator, who may suffer severe or fatal injury.

Kickback may occur, for example, when the chain near the upper quadrant of the bar nose contacts the wood or is pinched during limbing or when it is incorrectly used to begin a plunge or boring cut.

The greater the force of the kickback reaction, the more difficult it becomes for the operator to control the saw. Many factors influence the occurrence and force of the kickback reaction. These include chain speed, the speed at which the bar and chain contact the object, the angle of contact, the condition of the chain and other factors.

The type of bar and saw chain you use is an important factor in the occurrence and force of the kickback reaction. Some STIHL bar and chain types are designed to reduce kickback forces. STIHL recommends the use of reduced kickback bars and low kickback chains.

ANSI B 175.1-2000 chainsaw kickback standard

Section 5.12 of ANSI standard B 175.1-2000, sets certain performance and design criteria related to chainsaw kickback, which has been adopted for electric chain saws in UL 16 62 in section 30.

To comply with kickback § 30 of UL 16 62 electric chain saws:

- must, in their original condition, meet a 45° computer derived kickback angle when equipped with certain cutting attachments,
- and must be equipped with at least two devices to reduce the risk of kickback injury, such as a chain brake, low kickback chain, reduced kickback bar etc.

The computer derived angles for electric saws are measured by applying a computer program to test results from the kickback test machine.

⚠ Warning!

The computer derived angles of § 5.12 of ANSI B 175.1-2000 may bear no relationship to actual kickback bar rotation angles that may occur in real life cutting situations. Compliance with § 5.12 of ANSI B 175.1-2000 does not automatically mean that in a real life kickback the bar and chain will rotate at most 45°.

⚠ Warning!

In order for electric chainsaws to comply with the computed kickback angle requirements of § 30 of UL 16 62 / § 5.12 of ANSI B 175.1-2000 use only the following cutting attachments:

- bar and chain combinations listed as complying in the "Specifications" section of the Owner's Manual or
- other replacement bar and chain combinations marked in accordance with the standard for use on the powerhead or
- replacement chain designated "low kickback saw chain".

See the section on "Low kickback saw chain and reduced kickback bars"

Devices for reducing the risk of kickback injury

STIHL recommends the use of the STIHL Quickstop chain brake on your power-head with green labeled reduced kickback bars and low kickback chains.

⚠ Warning!

To reduce the risk of injury, stop using the saw immediately if the chain brake does not function properly. Take the saw to your local STIHL Service Center! Do not use the saw until the problem has been rectified (see the section "Chain Brake").

Quickstop chain brake

STIHL has developed a chain stopping system designed to reduce the risk of injury in certain kickback situations. It is called a Quickstop chain brake. The Quickstop is available as standard equipment on your STIHL chainsaw and is available for installation on most older STIHL saws. Ask your dealer to retrofit your older model saw with a chain brake.

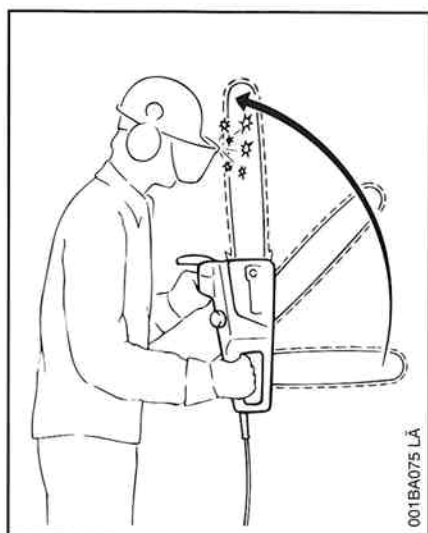

When a kickback occurs, the guide bar may rotate around the front handle. If the cutting position is such that the operator's left hand is gripping the front handle behind the hand guard, and if the left hand rotates around the front handle and makes a sufficiently forceful contact with the front hand guard, which is the Quickstop activating lever, this contact will activate the Quickstop. The chain brake on most new model STIHL chainsaws can also be activated by inertia. See the chapter entitled "Chain Brake" of your Owner's Manual.

On this electric chainsaw model, as soon as you release the trigger switch completely, the coasting chain brake is engaged and stops the chain. See the chapter entitled "Chain Brake" in your Owner's Manual.

⚠ Warning!

Never operate your chainsaw without a front hand guard. In a kickback situation this guard helps protect your left hand or other parts of your body. In addition, removal of the hand guard on a saw equipped with a chain brake will deactivate the chain brake.

⚠ Warning!

No Quickstop or other chain brake device prevents kickback. These devices are designed to reduce the risk of kickback injury, if activated, in certain kickback situations. In order for the Quickstop to reduce the risk of kickback injury, it must be properly maintained and in good working order. See the chapter entitled "Chain Brake" and "Maintenance, Repair and Storing" of your Owner's Manual. In addition, there must be enough distance between the bar and the operator to ensure that the Quickstop has sufficient time to activate and stop the chain before potential contact with the operator.

⚠ Warning!

An improperly maintained chain brake may increase the time needed to stop the chain after activation, or may not activate at all.

Low kickback saw chain and reduced kickback bars

STIHL offers a variety of bars and chains. STIHL reduced kickback bars and low kickback chains are designed to reduce the risk of kickback injury. Other chains are designed to obtain higher cutting efficiency or sharpening ease but may result in higher kickback tendency.

STIHL has developed a color codesystem to help you identify the STIHL reduced kickback bars and low kickback chains. Cutting attachments with green warning decals or green labels on the packaging are designed to reduce the risk of kickback injury. The matching of green decalated electric chainsaws with green labeled bars and green labeled chains gives compliance with the computed kickback angle requirements of § 30 of UL 16 62 / ANSI B 175.1-2000 when the products are in their original condition. Products with yellow decals or labels are for users with extraordinary cutting needs and experience and specialized training for dealing with kickback.

STIHL recommends the use of its green labeled reduced kickback bars, green labeled low kickback chains and a STIHL Quickstop chain brake for both experienced and inexperienced chainsaw users.

Please ask your STIHL dealer to properly match your powerhead with the appropriate bar/chain combinations to reduce the risk of kickback injury. Green labeled bars and chains are recommended for all powerheads. See your "STIHL Bar and Chain Information" leaflet for details.

⚠ Warning!

Use of other, non-listed bar/chain combinations may increase kickback forces and increase the risk of kickback injury. New bar/chain combinations may be developed after publication of this literature, which will, in combination with certain electric chainsaws, comply with § 30 of UL 16 62 / § 5.12 of ANSI B 175.1-2000. Check with your STIHL dealer for such combinations.

⚠ Warning!

Reduced kickback bars and low kickback chains do not prevent kickback, but they are designed to reduce the risk of kickback injury. They are available from your STIHL dealer.

⚠ Warning!

Even if your saw is equipped with a Quickstop, a reduced kickback bar and/ or low kickback chain, this does not eliminate the risk of injury by kickback. Therefore, always observe all safety precautions to avoid kickback situations.

Low kickback chain

Some types of saw chain have specially designed components to reduce the force of nose contact kickback. STIHL has developed low kickback chain for your powerhead.

"Low kickback saw chain" is a chain which has met the kickback performance requirements of § 5.12.2.4 of ANSI B 175.1-2000 (Safety Requirements for Gasoline-Powered Chainsaws) when tested on a selected representative sample of chainsaws below 3.8 cubic inch (62 cm³) displacement specified in ANSI B 175.1-2000.

⚠ Warning!

There are potential powerhead and bar combinations with which low kickback saw chains can be used which have not been specifically certified to comply with the 45° computer derived kickback angle of § 5.12 of ANSI B 175.1-2000. Some low kickback chains have not been tested with all powerhead and bar combinations.

⚠ Warning!

A dull or improperly sharpened chain may reduce or negate the effects of the design features intended to reduce

kickback energy. Improper lowering or sharpening of the depth gauges or shaping of the cutters may increase the chance and the potential energy of a kickback. Always cut with a properly sharpened chain.

Reduced kickback bar

STIHL green labeled reduced kickback bars are designed to reduce the risk of kickback injury when used with STIHL green labeled low kickback chains.

⚠ Warning!

When used with other, more aggressive chains, these bars may be less effective in reducing kickback, and may result in higher kickback forces.

Bow Guides

⚠ Warning!

Do not mount a bow guide on any STIHL chainsaw. Any chainsaw equipped with a bowguide is potentially very dangerous. The risk of kickback is increased with a bow guide because of the increased kickback contact area. Low kickback chain will not significantly reduce the risk of kickback injury when used on a bow guide.

To avoid kickback

The best protection from personal injury that may result from kickback is to avoid kickback situations:

1. Hold the chainsaw firmly with both hands and maintain a secure grip.
2. Be aware of the location of the guide bar nose at all times.
3. Never let the nose of the guide bar contact any object. Do not cut limbs with the nose of the guide bar. Be especially careful when cutting small, tough limbs, small size brush and saplings which may easily catch the chain.
4. Don't overreach.
5. Don't cut above shoulder height.
6. Begin cutting and continue at full throttle.
7. Cut only one log at a time.
8. Use extreme caution when reentering a previous cut.
9. Do not attempt to plunge cut if you are not experienced with this cutting technique.
10. Be alert for shifting of the log or other forces that may cause the cut to close and pinch the chain.
11. Maintain saw chain properly. Cut with a correctly sharpened, properly tensioned chain at all times.
12. Stand to the side of the cutting path of the chainsaw.

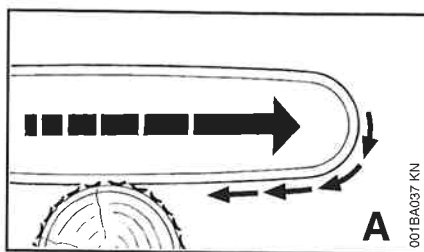

A = Pull-in:

Pull-in occurs when the chain on the bottom of the bar is suddenly stopped when it is pinched, caught or encounters a foreign object in the wood. The reaction of the chain pulls the saw forward and may cause the operator to lose control.

Pull-in frequently occurs when the bumper spike of the saw is not held securely against the tree or limb and when the chain is not rotating at full speed before it contacts the wood.

Warning!

Use extreme caution when cutting small size brush and saplings which may easily catch the chain and pull you off balance.

To avoid pull-in

1. Always start a cut with the chain rotating at full speed and the bumper spike in contact with the wood.
2. Pull-in may also be prevented by using wedges to open the kerf or cut.

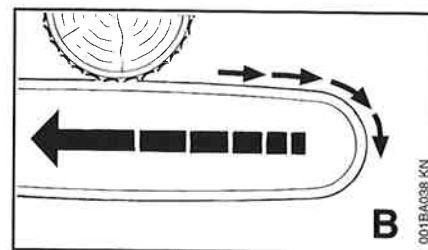

B = Pushback:

Pushback occurs when the chain on the top of the bar is suddenly stopped when it is pinched, caught or encounters a foreign object in the wood. The reaction of the chain drives the saw straight back toward the operator and may cause loss of saw control. Pushback frequently occurs when the top of the bar is used for cutting.

To avoid pushback

1. Be alert to forces or situations that may cause material to pinch the top of the chain.
2. Do not cut more than one log at a time.
3. Do not twist the saw when withdrawing the bar from a plunge cut or underbuck cut because the chain can pinch.

⚠ Warning!

Working with an electric chain saw in the woods - i.e. felling or limbing - is very dangerous. The freedom of movement necessary for this work is impaired by the power cable! Electric saws are intended for stationary use in yards, buildings, etc.

Cutting Techniques

These general instructions apply to all chain saws. As stated above, however, STIHL recommends against use of your electric saw in the woods.

Felling

Felling is cutting down a tree.

Before felling a tree, consider carefully all conditions which may affect the direction of fall, including:

- The intended direction of the fall.
- The natural lean of the tree.
- Any unusually heavy limb structure.
- Surrounding trees and obstacles.
- The wind direction and speed.

⚠ Warning!

Always observe the general condition of the tree. Inexperienced users should never attempt to cut trees which are decayed or rotted inside or which are leaning or otherwise under tension. There is an increased risk that such trees could snap or split while being cut and cause serious or fatal injury to the operator or bystanders. Also look for broken or dead branches which could vibrate loose and fall on the operator. When felling on a slope, the operator should stand on the uphill side if possible.

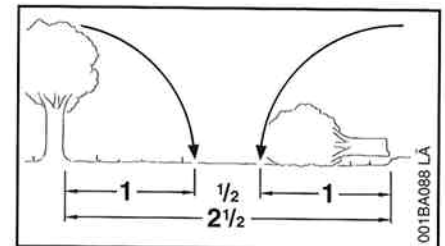

Felling Instructions:

When felling, maintain a distance of at least 2 1/2 tree lengths from the nearest person.

When felling in the vicinity of roads, railways and power lines, etc., take extra precautions. Inform the police, utility company or railway authority before beginning to cut.

⚠ Warning!

The noise of your engine may drown any warning call.

⚠ Warning!

There are a number of factors that may affect and change the intended direction of fall, e.g. wind, lean of tree, sloping ground, one-sided limb structure, wood structure, decay, snow load, etc. To reduce the risk of severe or fatal injury to yourself or others, look for these conditions prior to beginning the cut, and be alert for a change in direction while the tree is falling.

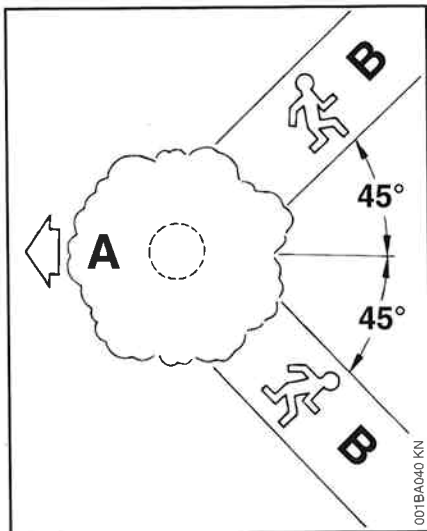

Escape path

First clear the tree base and work area from interfering limbs and brush and clean its lower portion with an axe.

Then, establish two paths of escape (B) and remove all obstacles. These paths should be generally opposite to the planned direction of the fall of the tree (A) and about at a 45° angle. Place all tools and equipment a safe distance away from the tree, but not on the escape paths.

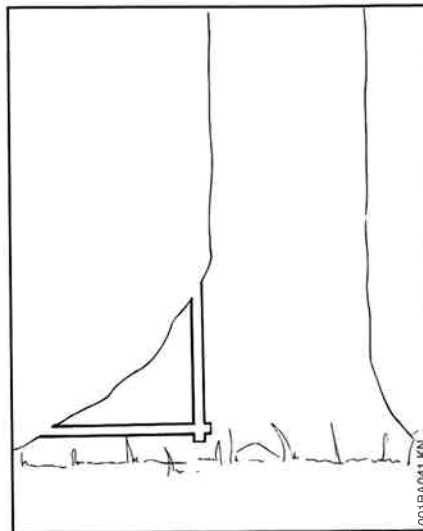

Buttress roots

If the tree has large buttress roots, cut into the largest buttress vertically first (horizontally next) and remove the resulting piece.

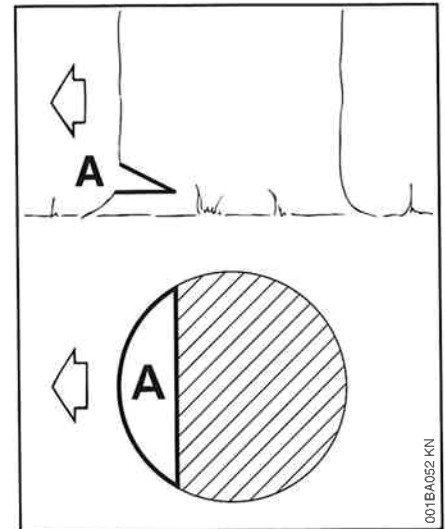

Conventional cut

A = felling notch - determines the direction of the fall

For a conventional cut:

- Properly place felling notch perpendicular to the line of fall, close to the ground
- Cut down at app. 45-degree angle to a depth of about 1/5 to 1/4 of the trunk diameter
- Make second cut horizontal
- Remove resulting 45-degree piece

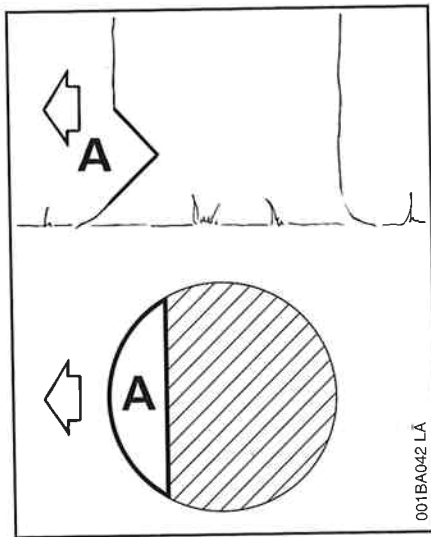

Open-face technique

A = felling notch - determines the direction of the fall

For an open-face cut:

- Properly place felling notch perpendicular to the line of fall, close to the ground
- Cut down at app. 50-degree angle to a depth of app. 1/5 to 1/4 of the trunk diameter
- Make second cut from below at app. 40 degree angle
- Remove resulting 90-degree piece

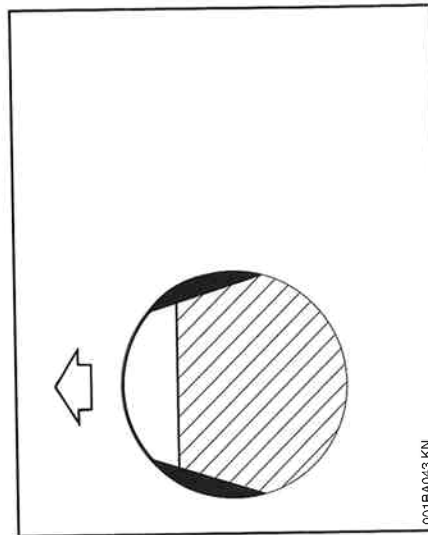

Making sapwood cuts

- For medium sized or larger trees make cuts at both sides of the trunk, at same height as subsequent felling cut
- Cut to no more than width of guide bar

This is especially important in softwood in summer - it helps prevent sapwood splintering when the tree falls.

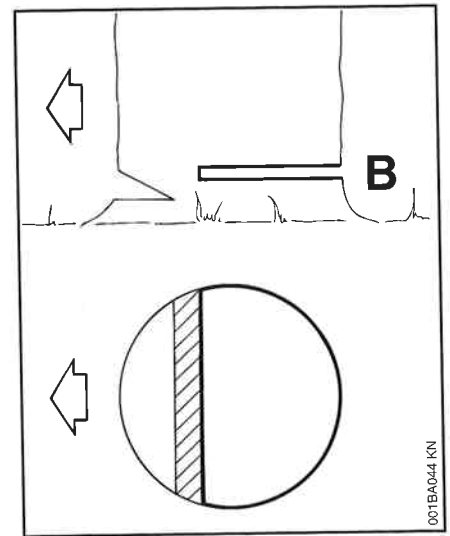

B = Felling cut

Conventional and open-face technique:

- Begin 1 to 2 inches (2,5 to 5 cm) higher than centre of felling notch
- Cut horizontally towards the felling notch
- Leave approx. 1/10 of diameter uncut. This is the hinge
- Do not cut through the hinge - you could lose control of the direction of the fall

Drive wedges into the felling cut where necessary to control the fall.

⚠ Warning!

If the tip of the bar contacts a wedge, it may cause kickback. Wedges should be of wood or plastic - never steel, which can damage the chain.

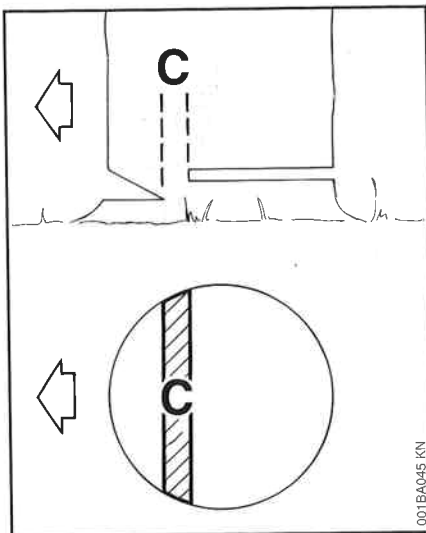

001BA045 KN

C = Hinge

- Helps control the falling tree
- Do not cut through the hinge -you could lose control of the direction of the fall

⚠ Warning!

In order to reduce the risk of personal injury, never stand directly behind the tree when it is about to fall, since part of the trunk may split and come back towards the operator (barber-chairing), or the tree may jump backwards off the stump. Always keep to the side of the falling tree. When the tree starts to fall, withdraw the bar, shut off the motor and walk away on the preplanned escape path. Watch out for falling limbs.

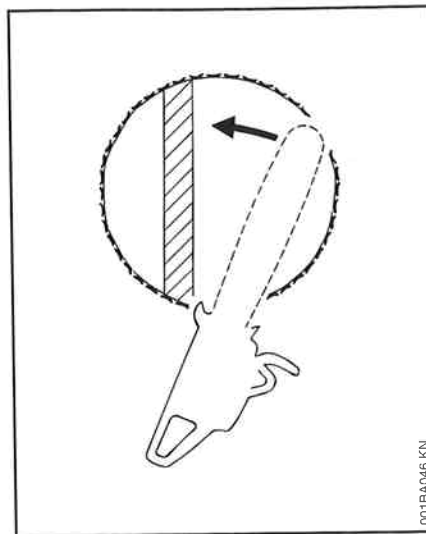

001BA046 KN

⚠ Warning!

Be extremely careful with partially fallen trees which are poorly supported. When the tree hangs or for some other reason does not fall completely, set the saw aside and pull the tree down with a cable winch, block and tackle or tractor. If you try to cut it down with your saw, you may be injured.

Felling cut for small diameter trees: simple fan cut

Engage the bumper spikes of the chainsaw directly behind the location of the intended hinge and pivot the saw around this point only as far as the hinge. The bumper spike rolls against the trunk.

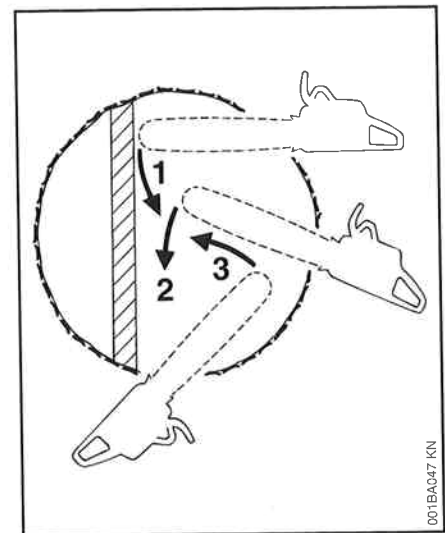

001BA047 KN

Felling cut for large diameter trees:

⚠ Warning!

Felling a tree that has a diameter greater than the length of the guide bar requires use of either the sectioning felling cut or plunge-cut method. These methods are extremely dangerous because they involve the use of the nose of the guide bar and can result in kickback. Only properly trained professionals should attempt these techniques.

Sectioning method

For the sectioning method make the first part of the felling cut with the guide bar fanning in toward the hinge. Then, using the bumper spike as a pivot, reposition the saw for the next cut.

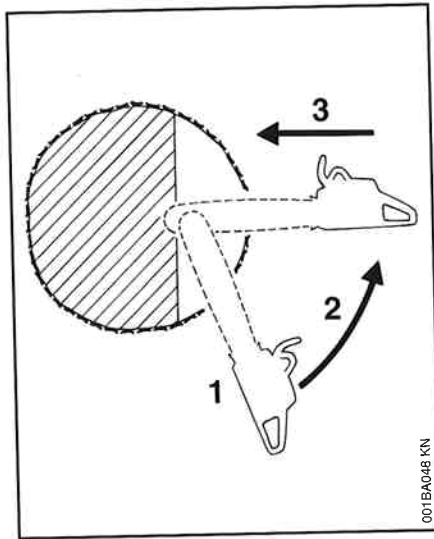

Avoid repositioning the saw more than necessary. When repositioning for the next cut, keep the guide bar fully engaged in the kerf to keep the felling cut straight. If the saw begins to pinch, insert a wedge to open the cut. On the last cut, do not cut the hinge.

Plunge-cut method

Timber having a diameter more than twice the length of the guide bar requires the use of the plunge-cut method before making the felling cut.

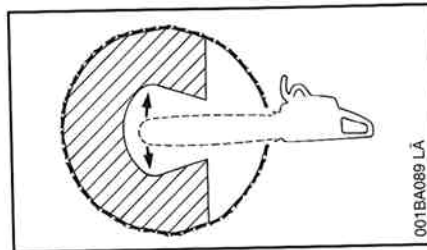

First, cut a large, wide felling notch. Make a plunge cut in the center of the notch.

The plunge cut is made with the guide bar nose. Begin the plunge cut by applying the lower portion of the guide bar nose to the tree at an angle. Cut until the depth of the kerf is about the same as the width of the guide bar. Next, align the saw in the direction in which the recess is to be cut.

With the saw at full speed, insert the guide bar in the trunk.

Enlarge the plunge cut as shown in the illustration.

⚠ Warning!

There is an extreme danger of kickback at this point. Extra caution must be taken to maintain control of the saw. To make the felling cut, follow the sectioning method described previously.

If you are inexperienced with a chainsaw, plunge-cutting should not be attempted. Seek the help of a professional.

Limbing

Limbing is removing the branches from a fallen tree.

⚠ Warning!

There is an extreme danger of kickback during the limbing operation. Do not work with the nose of the bar. Be extremely cautious and avoid contacting the log or other limbs with the nose of the guide bar.

Do not stand on a log while limbing it - you may slip or the log may roll.

Start limbing by leaving the lower limbs to support the log off the ground. When underbucking freely hanging limbs, a pinch may result or the limb may fall, causing loss of control. If a pinch occurs, stop the motor and remove the saw, by lifting the limb.

⚠ Warning!

Be extremely cautious when cutting limbs or logs under tension (spring poles). The limbs or logs could spring back toward the operator and cause loss of control of the saw and severe or fatal injury to the operator.

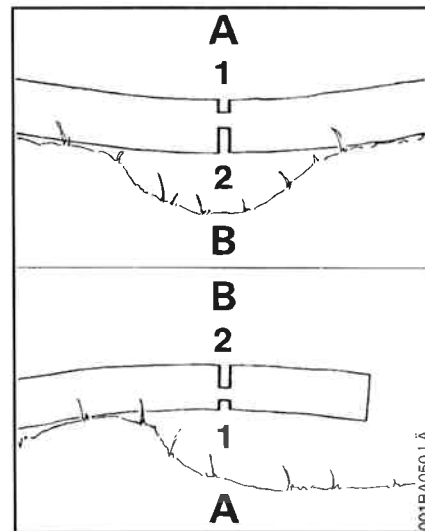

Bucking

Bucking is cutting a log into sections.

⚠ Warning!

1. When bucking, do not stand on the log. Make sure the log will not roll downhill. If on a slope, stand on the uphill side of the log. Watch out for rolling logs.
2. Cut only one log at a time.
3. Shattered wood should be cut very carefully. Sharp slivers of wood may be caught and flung in the direction of the operator of the saw.
4. When cutting small logs, place log through "V" - shaped supports on top of a sawhorse. Never permit another person to hold the log. Never hold the log with your leg or foot.
5. Logs under strain: Risk of pinching! Always start relieving cut (1) at compression side (A). Then make bucking cut (2) at tension side (B). If the saw pinches, stop the motor and remove it from the log.
6. Only properly trained professionals should work in an area where the logs, limbs and roots are tangled. Working in blow down areas is extremely hazardous.
7. Drag the logs into a clear area before cutting. Pull out exposed and cleared logs first.

MAINTENANCE, REPAIR AND STORING

Servicing of double-insulated appliance

This electric chainsaw is double-insulated. In such an appliance, two systems of insulation are provided instead of grounding. No grounding means are provided, nor should means for grounding be added to the appliance. Servicing a double-insulated appliance requires extreme care and knowledge of the system, and should be done only by qualified service personnel.

Replacement parts for double-insulated appliance must be identical to the parts they replace.

Use only identical STIHL replacement parts for maintenance and repair. Use of parts manufactured by others may cause serious or fatal injury.

Never operate a chainsaw that is damaged, improperly adjusted or not completely or securely assembled. Follow the maintenance and repair instructions in the appropriate section of your Owner's Manual, especially those in the chapters "Mounting the Bar and Chain" "Maintaining and Sharpening" and "Chain Brake".

Warning!

Always stop the motor, disconnect the plug from the power supply and ensure that the chain is stopped before making any adjustments, maintenance or repair work, changing the saw chain or cleaning the saw. Do not attempt any maintenance or repair work not described in your Owner's Manual. Have such work performed at your STIHL service shop only.

Keep the chain, bar and sprocket clean; replace worn sprockets or chains. Keep the chain sharp. You can spot a dull chain when easy-to-cut wood becomes hard to cut and burn marks appear on the wood. Keep the chain at proper tension. Tighten all nuts, bolts and screws before each use.

Only authorized personnel may replace the power supply cord. A damaged power supply cord must be replaced by an identical STIHL replacement part.

Warning!

In order for the chain brake on your STIHL chainsaw to properly perform its function of reducing the risk of kickback and other injuries, it must be properly maintained. Like an automobile brake, a chainsaw chain brake incurs wear each time it is engaged (see chapter "Chain Brake" in this manual).

The amount of wear will vary depending upon usage, conditions under which the saw is used and other factors.

Excessive wear will reduce the effectiveness of the chain brake and can render it inoperable. For proper and effective operation of the chain brake, the brake band and drum must be kept free of dirt, grease and other foreign matter which may reduce brake performance on the drum.

For these reasons, each STIHL chainsaw should be returned to trained personnel such as your STIHL servicing dealer for periodic inspection and servicing of the brake system according to the following schedule:

Heavy usage - every three months,
Moderate usage - twice a year,
Occasional usage - annually.

The chainsaw should also be returned immediately for maintenance whenever the brake system cannot be thoroughly cleaned or there is a change in its operating characteristics.

Additionally, the daily maintenance schedule for your chainsaw set forth in your STIHL Owner's Manual should be strictly followed.

Store chainsaw in a dry locked place and away from children. It should have the scabbard mounted or be in a carrying case.

**Read all instructions -
Save these instructions**

Mounting the Bar and Chain

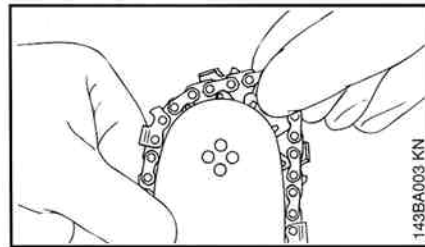
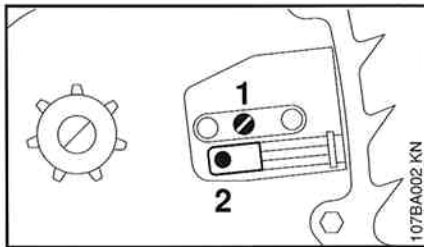
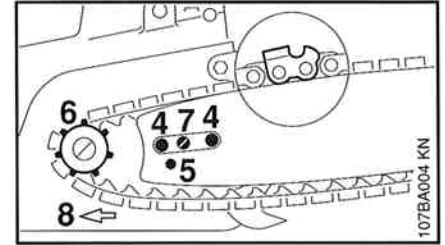
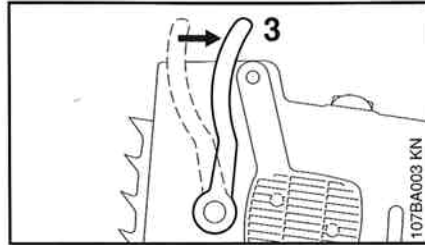
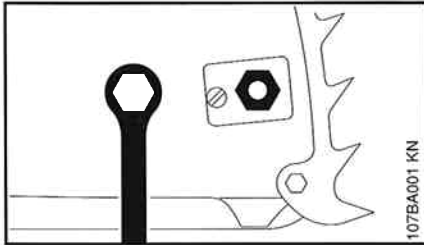

You can run chains of different pitches on this chainsaw - depending on the chain sprocket (see Specifications). The chain pitch must match the pitch of the sprocket and guide bar. The drive link gauge must match the guide bar groove width.

⚠ Do not connect saw to the power supply yet.

- Unscrew nut and take off the cover.
- Turn screw (1) counterclockwise until tensioner slide (2) butts against the left end of the housing slot.

Disengage the chain brake:
Pull hand guard (3) toward the front

- Wear work gloves to protect hands.
- Fit the chain on the bar - start at the bar nose.

- Turn the guide bar so that the chain cutting edges on the top of the bar point toward the bar nose (see illustration).
- Fit the guide bar over the studs (4) and engage the peg of the tensioner slide in the locating hole (5) - place the chain over the sprocket (6) at the same time.

- Now turn tensioning screw (7) clockwise until there is very little chain sag on the underside of the bar and the drive link tangs are located in the bar groove.

- Refit the sprocket cover and screw on the nut fingertight.

Arrow (8) indicates direction of chain rotation.

- Now refer to chapter "Tensioning the Saw Chain"

Tensioning the Saw Chain

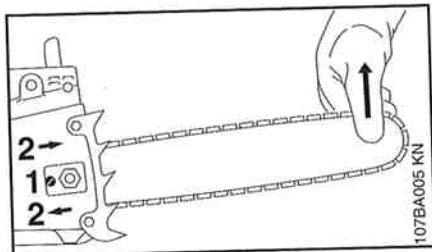

Retensioning during cutting work:

- ⚠
- **Disconnect saw from power supply**
- Disengage the chain brake.
- Slacken off the nut.
- Hold the bar nose up and use screwdriver to turn the tensioning screw (1) clockwise until chain fits snugly against the underside of the bar. While still holding bar nose up, tighten the nut **firmly**.
- Now refer to chapter "Checking Chain Tension"

Arrows (2) show direction of rotation of chain.

Checking Chain Tension

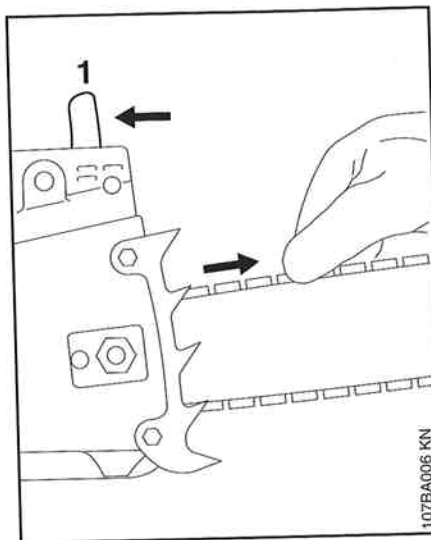

- **Disconnect saw from power supply**
- Wear work gloves.
- Disengage the chain brake: Pull hand guard (1) toward the front handle.

The chain must fit snugly against the underside of the bar and it must still be possible to pull the chain along the bar by hand.

- If necessary, retension the chain.

Note: A new chain has to be retensioned more often than one that has been in use for some time.
Check chain tension frequently - see section "During Operation".

Chain Oil

For automatic and reliable lubrication of the chain and guide bar:

Use only a quality, environmentally compatible chain and bar lubricant. STIHL chain lubricant with non-fling additive or the rapidly biodegradable STIHL Bioplus is recommended.

Important: Biological chain oil must be resistant to aging (e.g. STIHL Bioplus) since it will otherwise quickly turn to resin. This results in hard deposits that are difficult to remove, especially in the area of the chain drive, clutch and chain. It may even cause the oil pump to seize.

The service life of the chain and guide bar depends on the quality of the lubricant. It is therefore essential to use only a specially formulated chain lubricant.

If special chain lubricant is not available, you may - in an emergency - use an HD single grade or multigrade engine oil with a viscosity that suits the prevailing outside temperature.

⚠ Warning!

Medical studies have shown that renewed contact with waste oil can cause skin cancer. Avoid direct contact with waste oil. If waste oil does get on your skin, wash with soap and water.

Do not use waste oil for any purpose, and dispose of it only at authorized disposal locations.

Filling Chain Oil Tank

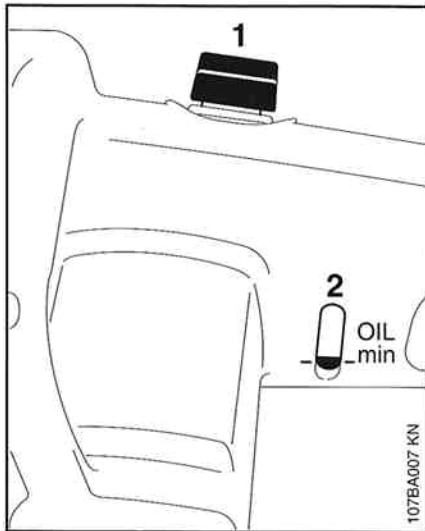

- Thoroughly clean the filler cap (1) and the area around it to ensure that no dirt falls into the tank.
- Fill up with chain oil.
- Check oil level regularly during operation.
- Top up chain oil tank when the "min" mark (2) is reached.

If the oil level does not drop, this may be due to a fault in the oil supply system: Check chain lubrication, clean the oilways, contact your STIHL dealer for assistance if necessary.

Chain Brake

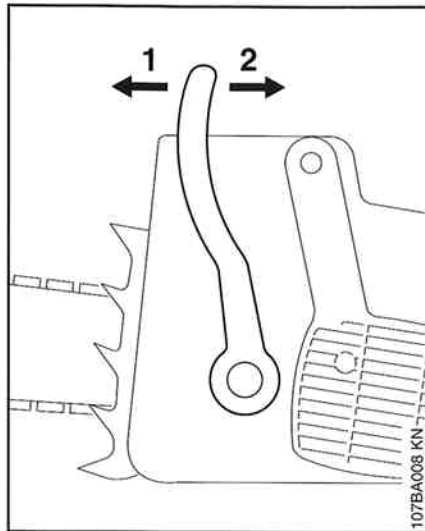

Activating chain brake manually in an emergency:

- The chain is stopped and locked when the hand guard (1) is pushed toward the bar nose by the left hand.

Releasing the chain brake

- Pull the hand guard (2) back toward the front handle.

The chain brake is activated by the inertia of the front hand guard if the kickback force of the saw is high enough:

The hand guard is accelerated toward the bar nose - even if your left hand is not behind the hand guard, e.g.

during felling cut. The chain brake will operate only if the hand guard has not been modified in any way.

Check operation of chain brake

Before starting work:

The hand guard must be free of dirt and move freely.

- Disengage the chain brake.
- Switch on the saw.
- Push hand guard in direction of bar nose. The chain brake is working properly if the chain comes to a standstill within a few fractions of a second.

Chain brake maintenance

The chain braking system is subject to normal wear. It must therefore be checked and serviced regularly by trained personnel (e.g. STIHL dealer) at the following intervals:

Full-time professional users:	every 3 months
Semi-professional (farm and construction industry):	every 6 months
Hobby and occasional users:	every 12 months

Connecting Saw to Power Supply

The **voltage of your power supply** and the **voltage specified on the saw** must be the same.

Outdoor operation: Connect the saw via a ground-fault circuit breaker. Extension cord must be suitable for outdoor use.

Mains power outlet: Must be equipped with a fuse or automatic circuit breaker. If the fuse or circuit breaker is tripped when you switch on the saw, use an extension cord (at least 10m/35 ft long) that meets the specifications in the following table.

Extension cords:

Minimum wire size for extension cords for 120 Volt appliances:

cord types:	SJW-A or SJTW-A		
Round jacketed cords.			
cord length (feet)	50	100	150
wire size (AWG)	14	12	10

Using not more than 15 amps:

cord length (feet)	50	100	150
wire size (AWG)	10	*	*

* not recommended

Listed by UL, W-A marking on cable jacket indicates "use outdoor". Appropriate extension cords are available in special stores for electrical equipment.

Cable drum: Always unwind the cord completely. It should be equipped with thermal protection.

Switching On

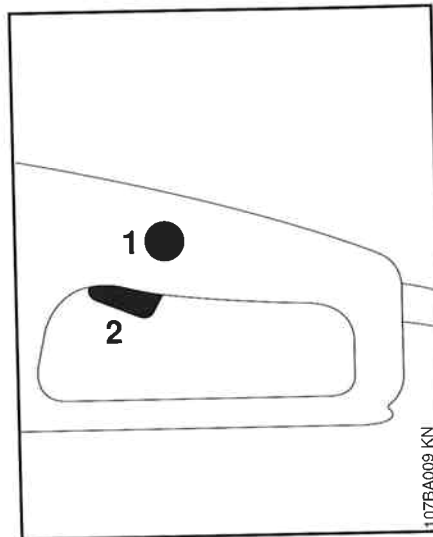

- Make sure you have a firm footing.
- Check that bystanders are well clear of general work area of the saw.
- Hold the saw firmly with both hands.
- Disengage the chain brake by pulling hand guard back toward the front handle.
- Check that the chain is not touching any object or the ground.
- Press in the trigger switch interlock (1) with your thumb.
- Squeeze the trigger switch (2) with your index finger.
- Start cutting with the chain running.

Switching Off

- Release the trigger switch so that it can return to the off position (1). It is then locked in this position by the trigger switch interlock.

Overload Circuit Breaker

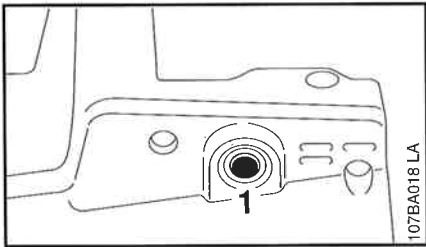

The overload circuit breaker cuts off the power supply to the saw in the event of mechanical overload due to, e.g.

- excessive infeed force,
- "lugging down" the motor,
- pinching the saw chain in the cut.

If the overload circuit breaker has cut off the power supply:

- Pull the guide bar out of the cut.
- Wait for the overload circuit breaker to cool down (about 20 seconds).
- Disengage chain brake if necessary.
- Press in button (1) as far as stop.

If the motor does not start when you switch on, you can assume that the overload circuit breaker has not cooled down sufficiently. Wait a little longer and then press the button again as far as stop.

When the motor starts again:

- Run your saw for about 15 seconds off-load. This helps cool the motor and helps prevent the overload circuit breaker being tripped again.

Checking Chain Lubrication

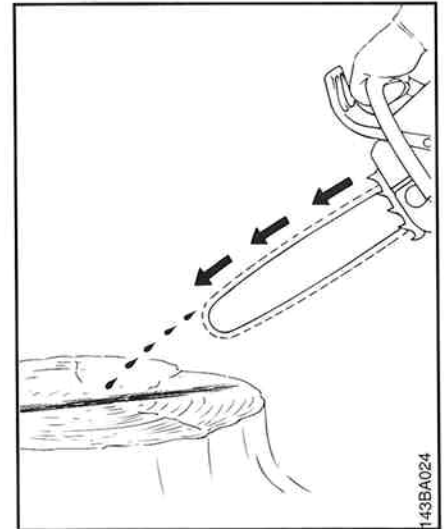

The saw chain must always throw off a small amount of oil.

- Never operate your saw without chain lubrication. If the chain is run dry the whole cutting attachment will be irretrievably damaged within a very short time. Always check chain lubrication and oil level in tank before starting work.
- Every new chain has to be broken in for about 2 to 3 minutes.
- After breaking in chain, check chain tension and adjust if necessary - see section "Checking Chain Tension".

During Operation

- Check level in chain oil tank.
- Fill up with fresh chain oil when the level reaches the "min" mark - see "Filling Chain Oil Tank"
- Begin cutting with the saw chain running.
- Always cut with a properly sharpened chain and apply only **moderate feed pressure**. The sound and running behavior of the saw must remain constant. The motor speed may only drop a little in the cut - **the chain must not jerk or stop**.
- If the motor slows down suddenly or the chain stops, reduce feed pressure **immediately** to avoid overheating and possible damage to the saw.

When saw is cold

- Refer to chapter "Checking Chain Tension".

Saw at operating temperature:

The chain stretches and begins to sag. The drive links on the underside of the bar must not come out of the bar groove - the chain may otherwise jump off the bar.

- Retension the chain - see section "Tensioning the Saw Chain".
- Disconnect saw from the power supply

After Finishing Work

- **Slacken off the chain** if you have retensioned it at operating temperature during cutting work.



The chain contracts as it cools down. If it is not slackened off, it could damage the drive shaft and bearings.

Taking Care of Guide Bar

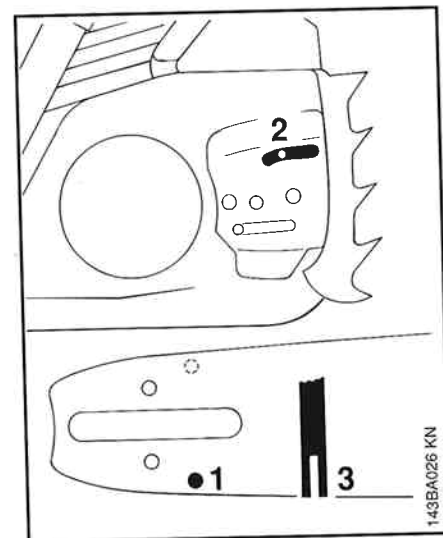

- **Turn the guide bar over** - every time you sharpen the chain - and every time you replace the chain - this helps avoid one-sided wear, especially at the nose and underside of the bar.

Regularly clean:

- 1 = oil inlet hole
- 2 = oilway
- 3 = bar groove.

Checking and Replacing the Chain Sprocket

- **Measure groove depth** - with scale on filing gauge* - in area of nose on Duromatic bars - or in area used most for cutting on Rollomatic bars.

Chain type	Chain pitch	Minimum groove depth
Rapid	3/8"	6.0 mm (0.24")

If groove depth is less than specified:

- Replace the guide bar.

The drive link tangs will otherwise scrape along the bottom of the groove - the cutters and tie straps will not ride on the rails.

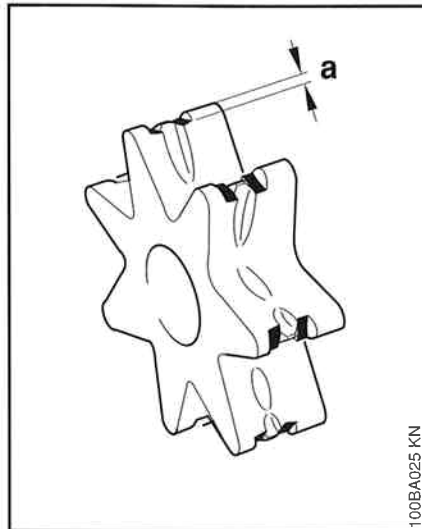

100BA025 KN

Replace the chain sprocket

- after using two Oilomatic chains.
- or even sooner if the wear marks (a) on the sprocket are deeper than approx. 0.5 mm ($1/64$ ") since this would reduce the life of the chain.

You can use gauge* 0000 893 4101 to check the depth of the wear marks on the sprocket.

Note: It is best to use two chains in rotation with one sprocket.

* Special accessory

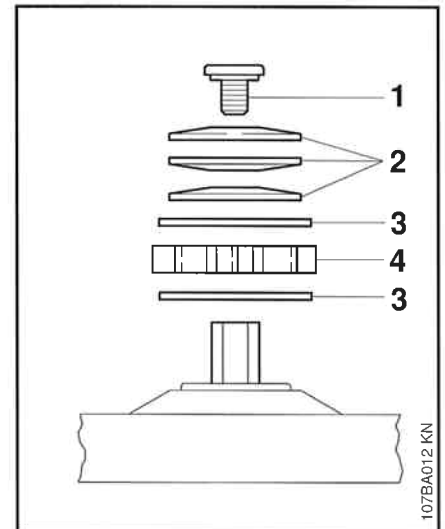

107BA012 KN

Before removing chain sprocket

- Disconnect saw from power supply
- Remove chain sprocket cover, chain and guide bar.
- Remove screw (1) from the shaft.
- Remove the cup springs (2), washers (3) and sprocket (4).

- Reverse the above sequence to install the new sprocket.

Important: Always use a new screw (1) when installing the chain sprocket.

Install all parts as shown in the illustration.

Motor Cooling

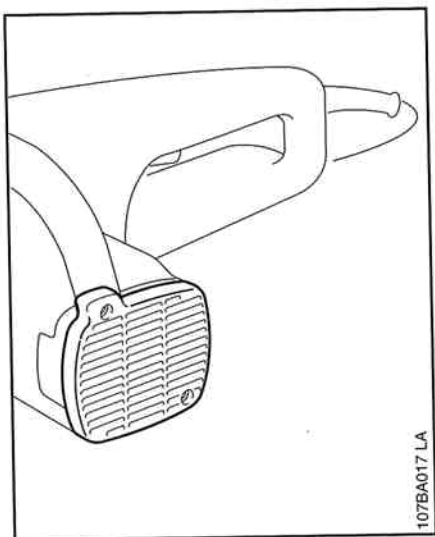

Cooling air flows to the motor through the slots in the commutator cover.

- Use a dry brush or similar tool to clean the cooling slots at regular intervals.

Storing the Machine

For periods of about 3 months or longer:

- Remove the saw chain and guide bar, clean them and protect with corrosion inhibiting oil.
- Thoroughly clean the machine
- If you use a biological chain and bar lubricant (e.g. STIHL Bioplus), completely fill the chain oil tank.
- Store the machine in a dry, high or locked location - out of the reach of children and other unauthorized persons.

Maintaining and Sharpening Saw Chain

Correctly sharpened chain

A properly sharpened chain slices through wood effortlessly and requires very little feed pressure.

Do not work with a dull or damaged chain as it will increase the physical effort required, produce unsatisfactory results and a higher rate of wear.

Clean and check your chain

for cracks in the links and damaged rivets -
replace any damaged or worn parts of the chain and match the new parts to the shape and size of the original parts.

Important: It is absolutely imperative to comply with the angles and dimensions specified below. If the **saw chain is incorrectly sharpened** - and in particular if the depth gauge is set too low - there is a risk of increased kickback of the chainsaw, with resulting **danger of injury**.

Select the appropriate sharpening tools for the chain pitch.

See "Technical Data" for the permitted chain pitches.

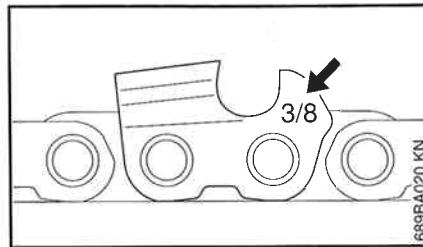

The chain pitch (e.g. 3/8) is marked on the depth gauge side of each cutter.

Use only special saw chain files

Other files have the wrong shape and cut.

Select file diameter according to chain pitch - see table at the end of this chapter.

You must observe certain angles when sharpening the chain cutters

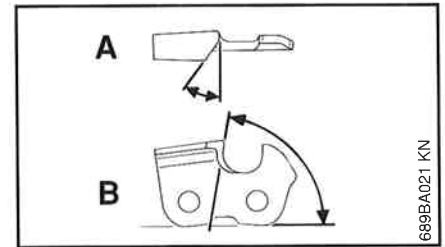

A = Filing angle

B = Side plate angle

Chain type	Angle (°)	
	A	B
Rapid-Micro (RM)	30	85
Rapid-Super (RS)	30	60
Picco-Micro (PM/PMN)	30	85

Cutter shapes:

Micro = Semi-chisel

Super = Full chisel

Specified angles A and B are obtained automatically if recommended files or sharpening tools and correct settings are used.

Furthermore, the angles must be the same on all cutters.

If angles are uneven:

Chain will run roughly, not in a straight line, wear quickly and finally break.

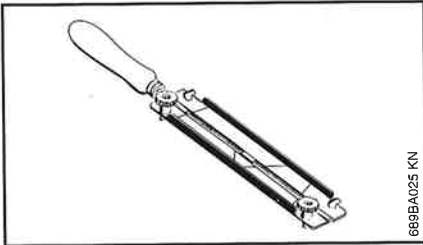

As these requirements can be met only after sufficient and constant practice:

Use a file holder.*

A file holder must be used for manual resharpening of Super chain. The correct filing angle is marked on the file holder.

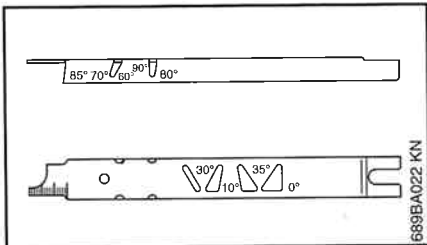

For checking angles

STIHL filing gauge* (see table)
A universal tool for checking the filing and side plate angles, depth gauge setting and cutter length. Also cleans the guide bar groove and oil inlet hole.

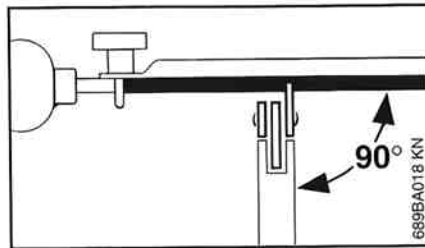

File correctly

- **Disconnect saw from power supply.**
- If you use a file holder or the FG 1: Leave the chain on the bar.
- Clamp the bar in a vise if necessary.
- To pull the chain along the bar, push the hand guard toward the front handle to disengage the chain brake. On E 140, 160 and E 180 C, hold the hand guard in this position to disengage the coasting brake.
- Sharpen chain frequently, take away as little metal as possible - two or three strokes of the file are usually enough
- Always file from the inside to the outside of the cutter.
- The file only sharpens on the forward stroke - lift the file off the cutter on the back-stroke.
- Hold the file **horizontally** for all chain types (at right angle to side of guide bar) and file according to the angles marked on the filing tool.
- Avoid touching the tie straps and drive links with the file.

- Rotate the file at regular intervals while filing - this avoids one-sided wear.
- Use a piece of hardwood to remove burrs from cutting edge.
- Check angles with the filing gauge.

All cutters must be the same length

If the cutters are not the same length, they will have different heights. This makes the chain run roughly and can cause it to break.

Find the shortest cutter and then file all other cutters back to the same length. This can be very time consuming - it is best to have it done in the workshop on an electric grinder.

* Special accessory

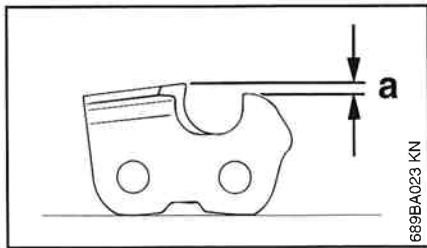

Depth gauge setting

The depth gauge determines the height at which the cutter enters the wood and thus the thickness of the chip removed.

Distance between depth gauge and cutting edge = **a**:

Chain pitch		Depth gauge distance "a"	
Inch	(mm)	mm	(Inch)
1/4	(6.35)	0.65	(0.026)
3/8-PM	(9.32)	0.65	(0.018)
3/8-PMN	(9.32)	0.45	(0.026)
0.325	(8.25)	0.65	(0.026)
3/8	(9.32)	0.65	(0.026)

This setting may be increased by 0.2 mm (0.008") for cutting softwood in mild weather season - no frost.

Lowering depth gauges

The depth gauge setting is reduced when the chain is sharpened. Use filing gauge to check the setting every time you sharpen the chain and, if necessary, lower the depth gauge with a flat or triangular file so that it is level with the filing gauge.

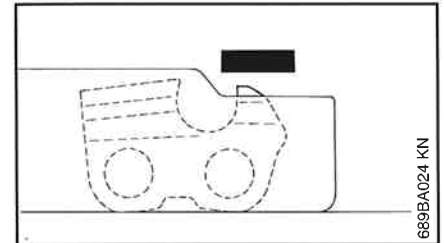

Round off depth gauges parallel to the stamped marking.

After sharpening

Clean the chain thoroughly, remove filings or grinding dust - lubricate the chain by immersing it in an oil bath.

Before long out-of-service period

Clean the chain with a brush and immerse it in an oil bath.

Sharpening tools

Chain pitch	Round file Ø	Round file	File holder	Filing gauge	Flat file	Sharpening kit*
Inch (mm)	mm (Inch)	Part No.	Part No.	Part No.	Part No.	Part No.
1/4 (6.35)	4.0 (5/32)	5605 772 4006	5605 750 4327	1110 893 4000	0814 252 3356	5605 007 1027
3/8 PMN (9.32)	4.0 (5/32)	5605 772 4006	5605 750 4327	0000 893 4000	0814 252 3356	5605 007 1026
3/8 P (9.32)	4.0 (5/32)	5605 772 4006	5605 750 4327	1110 893 4000	0814 252 3356	5605 007 1027
0.325 (8.25)	4.8 (3/16)	5605 772 4806	5605 750 4328	1110 893 4000	0814 252 3356	5605 007 1028
3/8 (9.32)	5.2 (13/64)	5605 772 5206	5605 750 4329	1110 893 4000	0814 252 3356	5605 007 1029

* consisting of file holder with round file, flat file and filing gauge.

Maintenance Chart

Please note that the following maintenance intervals apply for normal operating conditions only. If your daily working time is longer than normal or cutting conditions are difficult (very dusty work area, wood that produces a lot of pitch, tropical wood etc.), shorten the specified intervals accordingly.

		before starting work	after finishing work or daily	weekly	monthly	if faulty	if damaged	as required	see page:
Complete machine	Visual inspection (condition, leaks)	X							
	Clean		X						
Switch	Check operation	X							24
Chain brake, coasting brake	Check operation	X							23
	Have cleaned by STIHL dealer							X	23
Chain oil tank	Clean				X				
Chain lubrication	Check	X							25
Saw chain	Inspect, also check sharpness	X							29
	Check chain tension	X							22
	Sharpen							X	29
Guide bar	Check (wear, damage)	X							26
	Clean and turn over			X		X			26
	Deburr							X	
	Replace						X	X	27
Chain sprocket	Check			X					27
Cooling inlets	Clean		X						28
All accessible screws and nuts	Retighten							X	
Chain catcher on chain sprocket cover	Check			X					
	Replace chain sprocket cover						X		
Power cord	Check	X							
	Have replaced by STIHL dealer						X		

Specifications

Motor

Rated voltage:	120 V
Frequency:	60 Hz
Rating:	1.8 kW
Fuse (slow blowing):	15 A
Enclosure:	IP 20
Insulation:	Type II
Amp-Rating	15 A

Sound pressure level L_p (1 m)
to prEN 50144-2-13¹⁾:

97 dB (A)

Sound power level L_w
to prEN 50144-2-13¹⁾:

110 dB (A)

Vibration

to prEN 50144-2-13²⁾

Handle, left:	4.1 m/s ²
Handle, right:	12.0 m/s ²

1) without load

2) with load

Chain lubrication:	Fully automatic, speed controlled
Oil tank capacity:	0.20 l (0.42 US pt)

Weight without bar and chain
E 220:

5.0 kg (11.0 lb)

Cutting Attachment

Recommended cutting attachments
for compliance with § 30 of UL 1662 /
§ 5.12 of ANSI Standard B 175.1-2000

STIHL reduced kickback bar
(with green label): for 3/8" pitch
Rollomatic with sprocket nose
37, 40, 45 or 50 cm (15, 16, 18 or 20 in)
STIHL low kickback chain (with green label):
9.32 mm (3/8") Rapid Micro 2
(33 RM 2, 36 RM 2)
Chain sprocket: 8-tooth for 3/8" pitch

Since new bar/chain combinations may be
developed after publication of this Manual,
ask your STIHL dealer for the latest STIHL
recommendations.

Other cutting attachments available for this
powerhead are: STIHL yellow-labeled bar:
Rollomatic "S" with sprocket nose
37, 40, 45, or 50 cm (15, 16, 18 or 20 in)
Duromatic with stellite tipped nose
37, 40, 45, or 50 cm (15, 16, 18 or 20 in)
STIHL yellow-labeled chain:
with 3/8" pitch: Rapide-Micro (33/36 RM)
and Rapid-Super (33/36 RS)

In order to comply with the kickback
performance requirements of § 30 of UL
1662 / § 5.12 of ANSI Standard
B 175.1-2000, do not use replacement saw
chain unless it has been designated as
meeting the § 30 of UL 1662/ANSI § 5.12
requirements on this specific powerhead,
or has been designated as "low kickback"
saw chain* in accordance with the
ANSI B 175.1-2000 standard.

* See definition of "low kickback chain"
on page 14 of this Manual.

5. Do not start cutting until you have a clear work area, secure footing, and a planned retreat path from the falling tree.
6. Keep all parts of your body away from the saw chain when the engine is running.
7. Before you switch on the motor, make sure that the saw chain is not contacting anything.
8. Carry the chainsaw with the motor stopped, the guide bar and saw chain to the rear.
9. Do not operate a chainsaw that is damaged, improperly adjusted, or not completely and securely assembled.
10. Shut off the motor before setting the chainsaw down.
11. Use extreme caution when cutting small size brush and saplings because slender material may catch the saw chain and be whipped toward you or pull you off balance.
12. When cutting a limb that is under tension be alert for springback so that you will not be struck when the tension in the wood fibers is released.
13. Keep the handles dry, clean, and free of oil.
14. Do not operate a chainsaw in a tree unless you have been specifically trained to do so.
15. All chainsaw service, other than the items listed in the Owner's Manual maintenance instructions, should be performed by competent chainsaw service personnel.
16. When transporting your chainsaw, use the appropriate chain guard (scabbard).
17. Reduced kickback bars and low kickback chains are designed to reduce the risk of kickback injury. Ask your STIHL dealer about these devices.

Other important safety precautions are contained in the body of the Owner's Manual.

Note:

When using a chainsaw for logging purposes, refer to the Code of Federal Regulations, Parts 1910 and 1928.