

Instruction Manual/Owner's Manual

# STIHL FS 61



**STIHL**®

**Warning:**  
Always follow safety precautions in  
owner's manual – improper use  
can cause serious injury!

## STIHL FS 61 E, FS 61 RE

### CONGRATULATIONS!

You are the owner of a precision-manufactured STIHL Brushcutter designed to give you long and dependable service. To receive maximum performance and satisfaction from your STIHL Brushcutter, it is important that you read and understand the maintenance and safety precautions before using your Brushcutter. Contact your STIHL Dealer or the STIHL Distributor for your area if you do not understand any of the instructions or warnings in this Manual.

This Manual contains warnings, operating and safety instructions for your STIHL FS 61 E or FS 61 RE Brushcutter.

### Warning!

Because a Brushcutter is a high-speed cutting tool, some special safety precaution must be observed to reduce the risk of personal accidents. Careless or Improper use may cause serious or even fatal injury.

It is important that you fully understand the contents of this Manual and that you allow only persons who understand this Manual to operate your Brushcutter.

Pay special attention to the operating techniques (page 10 to 13 and **safety precautions** outlined on pages 6 to 13.

STIHL's philosophy is to continually improve all of its products. As a result, engineering changes and improvements are made from time-to-time. Written notices relating to such changes are sent to STIHL Dealers. If the operating characteristics or the appearance of your Brushcutter differs from those described in this Manual, please contact your local STIHL Dealer for updated information and assistance.

### Owner's Manual

#### Contents

Parts and Controls of Brushcutter FS 61 E	2
Parts and Controls of Brushcutter FS 61 RE	4
Safety Precautions	6
– The Operator	6
– The Brushcutter	8
– The Use of the Brushcutter	8
– Maintenance, repair and storing	13
Assembling the Brushcutter	14
Fuel	18
Mounting the cutting tools	19
STIHL-“Polycut” head	20
STIHL-“Polymatic” nylon line head	21
STIHL-“Rotocut 220”	22
Grass cutting blade, brush knife 250, circular saw blade 200	23
Fitting the harness – balancing the brushcutter	24
Starting the FS 61 E	25
Starting the FS 61 RE	27
Carburetor	30
Air Filter	31
Repair of cutting tools	32
Sharpening the grass cutting blade	35
Sharpening the brush knife 250	35
Rewind starter	36
Maintenance chart	39
Specifications	40

**STIHL**®

Andreas Stihl  
Postfach 1760

D-7050 Waiblingen

1

## Parts and Controls of Brushcutter FS 61 E

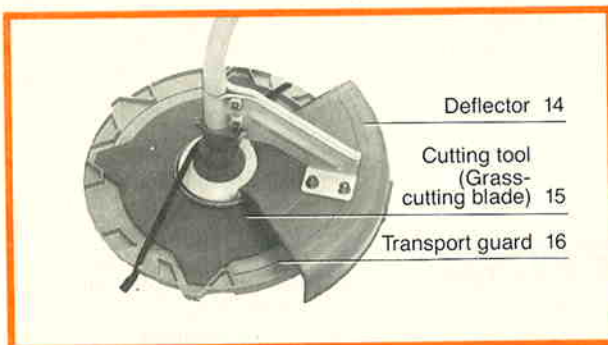
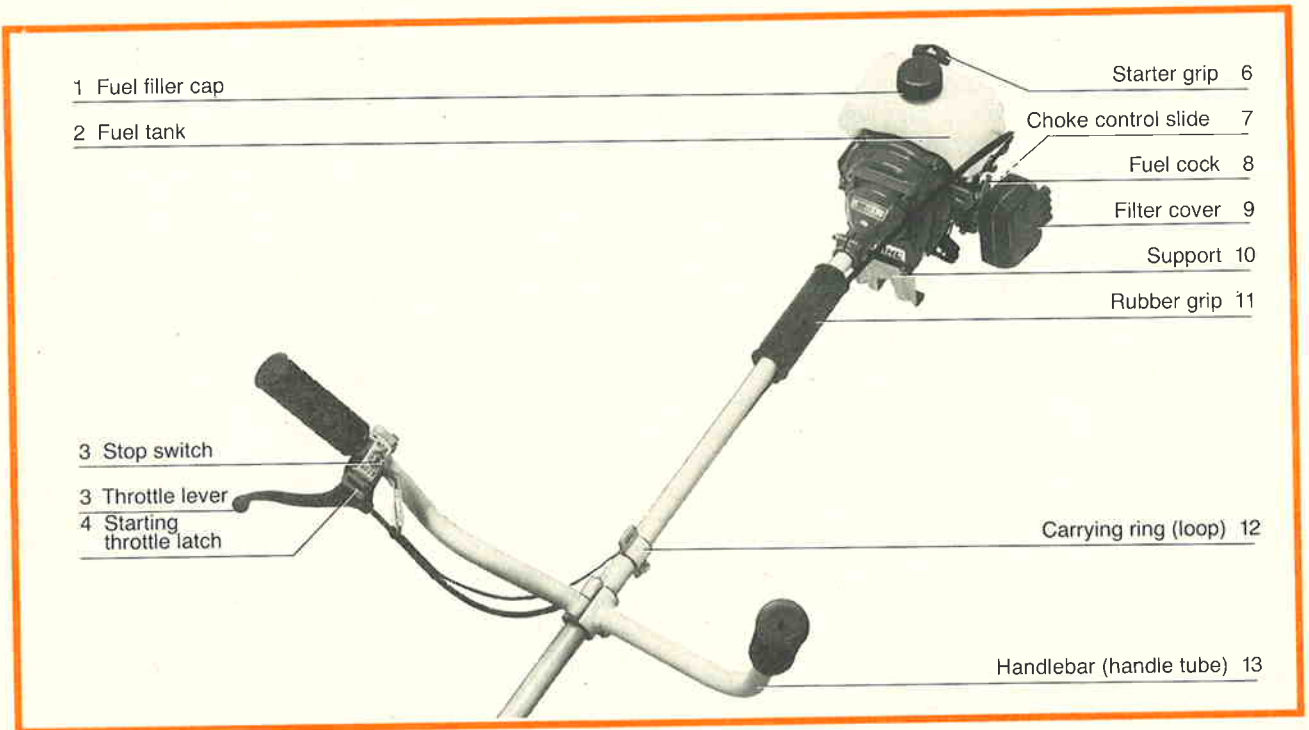

## Definitions

1. **Fuel filler cap**  
For closing the fuel tank.
2. **Fuel tank**  
For fuel and oil mixture.
3. **Stop switch**  
Switches the engine's ignition system off and stops the running engine.
4. **Throttle lever**  
Controls the speed of the engine.
5. **Starting throttle latch**  
Keeps the throttle partially open during starting.
6. **Starter grip**  
The grip of the pull starter, which is the device to start the engine.
7. **Choke control slide**  
Eases engine starting by enriching mixture.
8. **Fuel cock**  
Shutoff cock for interrupting the fuel supply from fuel tank to carburetor.
9. **Filter cover**  
Covers the air filter element.
10. **Support**  
For resting machine on the ground.
11. **Rubber grip**  
For holding machine during starting.
12. **Carrying ring (loop)**  
The device to connect the Brushcutter with the harness.
13. **Handlebars (handle tube)**  
To hold the Brushcutter with both hands.
14. **Deflector**  
The deflector is designed to reduce the risk of injury from foreign objects flung backwards toward the operator by the cutting tool and from contact with the cutting tool.
15. **Cutting tool**  
The cutting attachment made from different materials for different purposes.
16. **Transport guard**  
For all steel cutting tools when transporting the Brushcutter.
17. **Muffler**  
Attenuates exhaust noises and diverts exhaust gases in required direction.
18. **Spark plug terminal**  
Connects the spark plug with the ignition wire.

### **Harness**

To balance the weight of the Brushcutter on the shoulder to be free for a better control of the Brushcutter (not illustrated).

## Parts and Controls of Brushcutter FS 61 RE

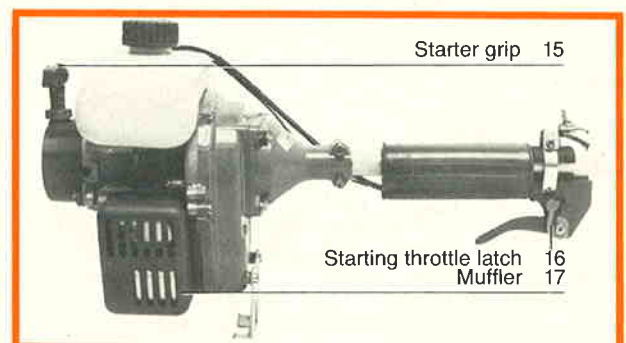
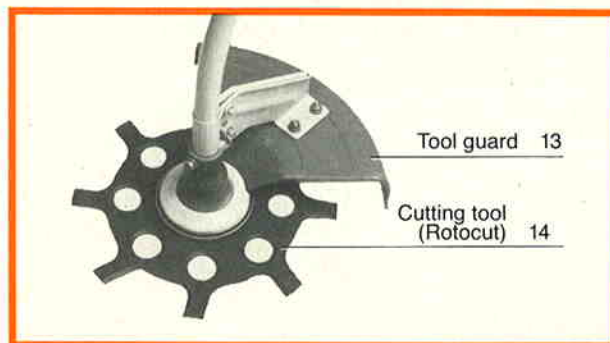
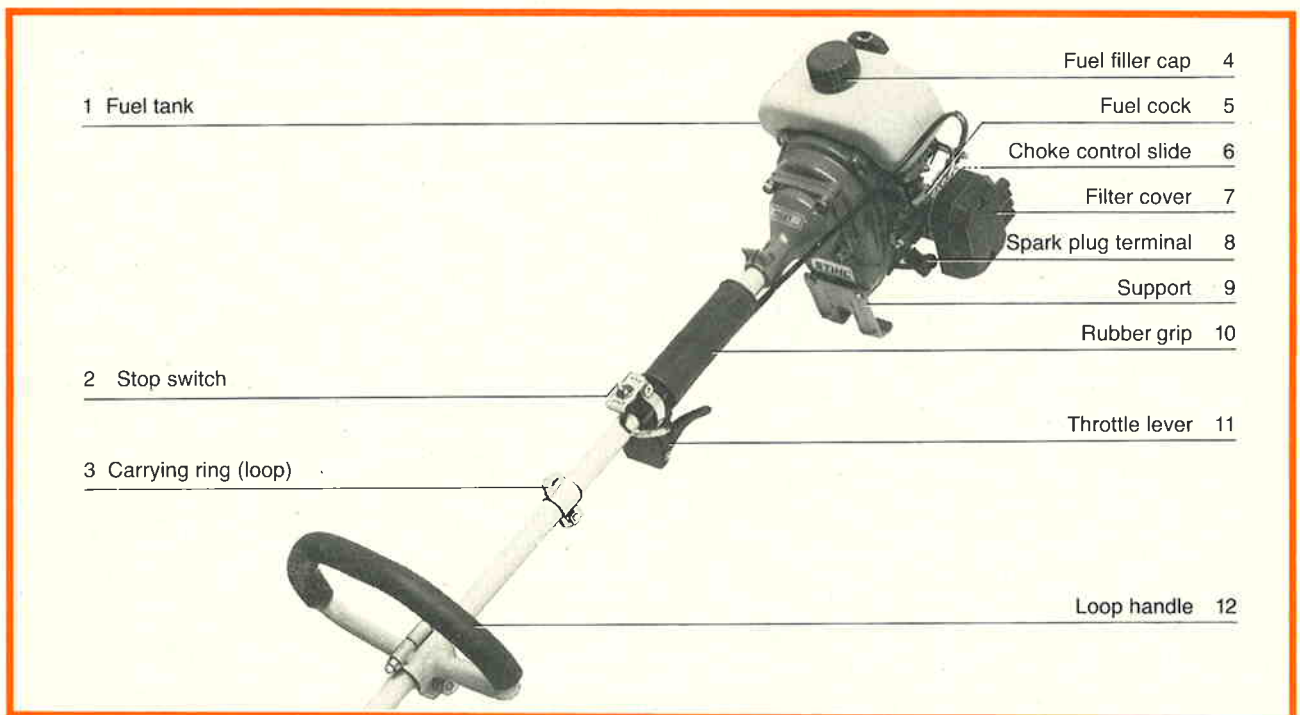

## Definitions

1. **Fuel tank**  
For fuel and oil mixture.
2. **Stop switch**  
Switches the engine's ignition system off and stops the running engine.
3. **Carrying ring (loop)**  
The device to connect the Brushcutter with the harness.
4. **Fuel filler cap**  
For closing the fuel tank.
5. **Fuel cock**  
Shutoff cock for interrupting the fuel supply from fuel tank to carburetor.
6. **Choke control slide**  
Eases engine starting by enriching mixture.
7. **Filter cover**  
Covers the air filter element.
8. **Spark plug terminal**  
Connects the spark plug with the ignition wire.
9. **Support**  
For resting machine on the ground.
10. **Rubber grip**  
For holding machine during starting.
11. **Throttle lever**  
Controls the speed of the engine.
12. **Loop handle**  
For easy control of machine during cutting work.
13. **Deflector**  
The deflector is designed to reduce the risk of injury from foreign objects flung backwards toward the operator by the cutting tool and from contact with the cutting tool.
14. **Cutting tool**  
The cutting attachment made from different materials for different purposes.
15. **Starter grip**  
The grip of the pull starter, which is the device to start the engine.
16. **Starting throttle latch**  
Keeps the throttle partially open during starting.
17. **Muffler**  
Attenuates exhaust noises and diverts exhaust gases in required direction.

### **Harness**

To balance the weight of the Brushcutter on the shoulder to be free for a better control of the Brushcutter (not illustrated).

### **Warning!**

Use FS 61 RE Brushcutter (with single loop handle) only with Polycut, Rotocut and Polymatic nylon line head cutting attachments. The use of any other polymer or metal cutting tools may cause serious injury if they come in contact with the operator.

## Safety Precautions



The use of any Brushcutter may be hazardous. If the rotating cutting tool comes in contact with your body, it will cut you. When it comes in contact with solid foreign objects such as rocks or bits of metal it may fling them in the direction of bystanders or – by ricochet – towards the operator.

### Warning!

Because a Brushcutter is a highspeed, fast cutting power tool, special safety precautions must be observed to reduce the risk of personal accidents.

It is important that you read, fully understand and observe the following safety precautions and warnings. Read the Owner's Manual **and** the safety instructions periodically. Careless or improper use of any Brushcutter may cause serious or fatal injury.

Have your STIHL dealer show you how to operate your Brushcutter. Observe all applicable local safety regulations, standards and ordinances.

### Warning!

Minors should never be allowed to use a Brushcutter. Bystanders, especially children and animals should not be allowed in the area where a Brushcutter is in use (ill. 1).

6



Never let the Brushcutter run unattended.

Do not lend your Brushcutter without the Owner's Manual. Be sure that anyone using your Brushcutter understands the information contained in this Manual.

These safety precautions and warnings apply to the use of all STIHL Brushcutters. Different models may have different parts and controls. See the appropriate section of your Owner's Manual for a description of the controls and function of the parts of your model Brushcutter.

Safe use of a Brushcutter involves

1. the Operator
2. the Brushcutter
3. the Use of the Brushcutter.

## THE OPERATOR

### Physical Condition

You must be in good physical condition and mental health and not under the influence of any substance (drugs, alcohol, etc.) which might impair vision, dexterity or judgment. Do not operate a Brushcutter when you are fatigued (ill. 2).

Be alert – if you get tired while operating your Brushcutter, take a break, tiredness may result in loss of control.

Working with any Brushcutter can be strenuous. If you have any condition that might be aggravated by strenuous work, check with your doctor before operating a Brushcutter.

**Warning!**

Prolonged use of Brushcutter (or other machines) exposing the operator to vibrations may produce Whitefinger disease (Raynaud's phenomenon). This phenomenon reduces the hand's ability to feel and regulate temperature, produces numbness and burning sensations and may cause nerve and circulations damage and tissue necrosis. Some STIHL models are available with an anti-vibration system designed to reduce engine vibration. An antivibration system is recommended for those using Brushcutters on a regular or sustained basis.

Antivibration systems do not guarantee that you will not sustain Whitefinger disease. Therefore continual and regular users should monitor closely their use of Brushcutters and their physical condition.

**Proper Clothing**

Clothing must be sturdy and snug-fitting, but allow complete freedom of movement. Avoid loose-fitting jackets, scarfs, neckties, jewelry, flared or cuffed pants or anything that could become caught on branches, brush or moving parts of the unit. Wear overalls or jeans or long pants to protect your legs (ill. 3). Do not wear shorts.

Protect your hands with gloves when handling the Brushcutter and the cutting tool. Heavy-duty, nonslip gloves improve your grip and protect your hands.

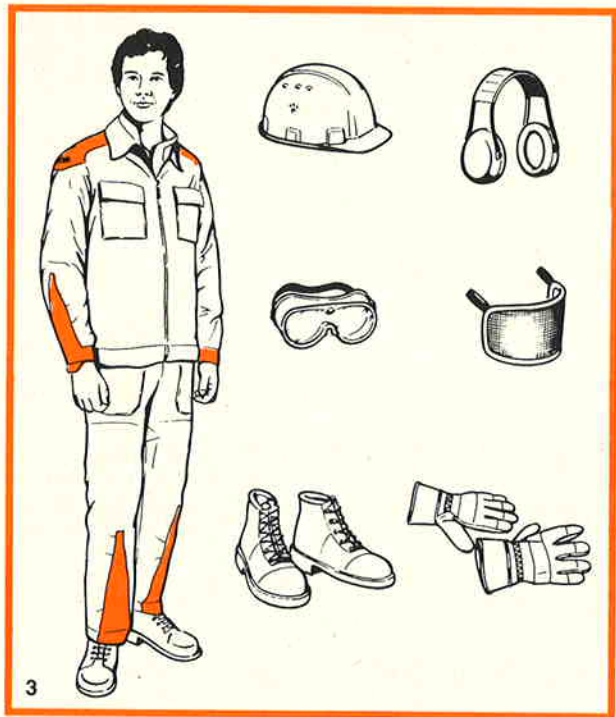

Good footing is most important in Brushcutter work. Wear sturdy boots with nonslip soles. Steel-toed safety boots are recommended.

Proper eye protection is a must.

Loose objects may be thrown toward the operator by this tool.

Non-fogging, vented safety goggles or a face screen is recommended. Their use reduces the risk of eye injury.



Wear an approved safety hard hat to protect your head when there is a danger of head injuries. Brushcutter noise may damage your hearing. Wear sound barriers (ear plugs or ear muffers) to protect your hearing.

Continual and regular users should have their hearing checked regularly.

## THE BRUSHCUTTER

Parts of the Brushcutters; illustrations and definitions of the parts see pages 2 and 3, 4 and 5!

### Warning!

Never modify a Brushcutter in any way. Only attachments supplied by STIHL or expressly approved by STIHL for use with the specific STIHL Brushcutter models are authorized. Although certain unauthorized attachments are useable for the STIHL Brushcutter, their use may, in fact, be extremely dangerous.

## THE USE OF THE BRUSHCUTTER

### Transporting the Brushcutter

#### Warning!

Always stop the engine before putting a Brushcutter down.

When transporting in a vehicle properly secure your Brushcutter to prevent turnover, fuel spillage and damage to the Brushcutter. Keep the cutting tool covered with the carrying guard.

### Preparation for the use of the Brushcutter

- 8 Adjust harness and hand grip to suit your stature before



starting work. The machine should be properly balanced as specified on page 24 for proper control and less fatigue in operation.

Always check your Brushcutter for proper condition and operation before starting. Particularly important items are the throttle lever, stop switch, cutting tool, deflector and harness.

The throttle lever must move freely and always spring back to the idle position. The cutting tool must be properly tightened and in safe operation condition. Inspect for loose parts (nuts, screws, etc.).

### Fueling

Your STIHL Brushcutter uses an oil-gasoline mixture for fuel (see page 23).

### Warning!

Gasoline is an extremely flammable fuel. Use extreme caution when handling gasoline or fuel mix. Do not smoke or bring any fire or flame near the fuel (ill. 4).

### Fueling Instructions

Fuel your Brushcutter in well-ventilated areas, outdoors only.

d areas, outdoors

to cool before re-  
loosening fuel cap  
engine is running.

ve at least 10 feet  
starting the engine.

your Brushcutter

and during opera-  
start or run the en-  
has been wiped  
nothing. If this hap-

chine. Make sure  
(30 ft) radius of the  
operating the unit.  
without assistance.

ns, see the appro-

other solid surface  
ance and secure

s clear of you and  
during the ground,  
throttle engine

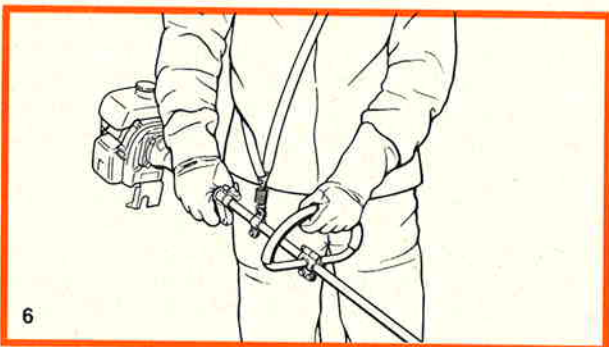
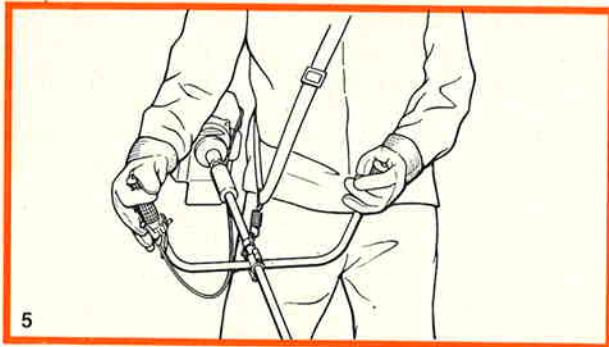

When you pull the starter grip, don't wrap the starter rope around your hand. Do not allow the grip to snap back, but guide the starter rope slowly back to permit the rope to re-wind properly. Failure to follow this procedure may result in injury to hand or fingers and may damage the starter mechanism.

### Working Conditions

Always hold the Brushcutter firmly with both hands. Wrap your fingers tightly around the handles, keeping the handles cradled between your thumb and forefinger. Keep your hands in this position, to have your Brushcutter under control at all times (ill. 5 = FS 61 E, ill. 6 = FS 61 RE). Make sure your Brushcutter handles and grip are in good condition and free of moisture, pitch, oil or grease.

**Warning!**

Never use the Brushcutter with one hand and without harness. You may lose control of the Brushcutter.

**Warning!**

Caution must be taken in slippery conditions (wet ground, snow). Watch for hidden obstacles such as tree stumps, roots and ditches to avoid stumbling. Inspect the area before cutting and remove all debris that could become entangled in the cutting head or thrown away while cutting.

Do not overreach. Keep proper footing and balance at all times.

The normal use of this tool is on ground level. Other cutting techniques are very dangerous and should be avoided. Only trained operators should attempt these techniques.

**Warning!**

Do not operate using the starting throttle latch as you do not have control of the engine speed. See page 25 to 29 for the proper use of the starting throttle latch.

If the cutting attachment or guard becomes clogged or stuck, always turn off the engine before cleaning. Grass, weeds, etc. should be cleaned off the cutting attachment at regular intervals.

During cutting, check the tightening and the condition of the cutting attachment at regular intervals. If the behavior of the tool changes stop the engine immediately and check the nut securing the tool for tightness and the cutting tool for cracks and damage.

**Warning!**

Replace bent, warped, damaged or dull cutting tools immediately. Serious or fatal injury may result from the use of such cutting tools.

**Important adjustments**

**Warning!**

At correct idle speed, the cutting tool should not turn. For directions to adjust idle speed, see the appropriate section of this Owner's Manual.

Do not use a Brushcutter with incorrect idle speed adjustment. Adjust the idle speed yourself according to the instructions in this Manual.

Have your STIHL Dealer check your Brushcutter and make proper adjustments or repairs.

**Warning!**

Never touch a rotating cutting tool with your hand or any part of your body. It continues to rotate for a short period after the throttle lever is released (flywheel effect).

**Warning!**

Do not cut any material other than grass, bush and wood.

**Operating instructions**

With the engine running, attach the Brushcutter to the spring hook of your harness.

The cutting tools may be used only for the operations described in this Manual.

**Warning!**

Use FS 61 RE Brushcutter (with single loop handle) only with Polycut, Rotocut and Polymatic nylon line head cutting attachments. The use of any other polymer or metal cutting tools may cause serious injury if they come in contact with the operator.

Brushcutter in operation



### Using the mowing heads

The mowing head is intended to supplement a lawn mower. It produces a clean and tidy finish even along ragged lawn edges.

If the lawn edges are planted with trees or bordered by a fence etc., it is best to use the "Polymatic" nylon line head or "Polycut" head with nylon line. These heads achieve a "softer" cut and there is less risk of damaging tree bark than with the polymer blades.

However, the polymer bladed STIHL-"Polycut" produces a better cut if there are no plants along the edge of the lawn.

Top: Lawn edging with the STIHL-"Polycut", STIHL-"Polymatic" or STIHL-"Rotocut 220"  
Bottom: Mowing around trees with the STIHL-"Polycut" (with nylon line) or STIHL-"Polymatic"

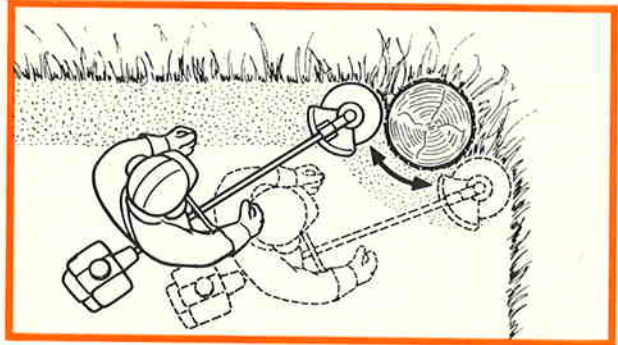
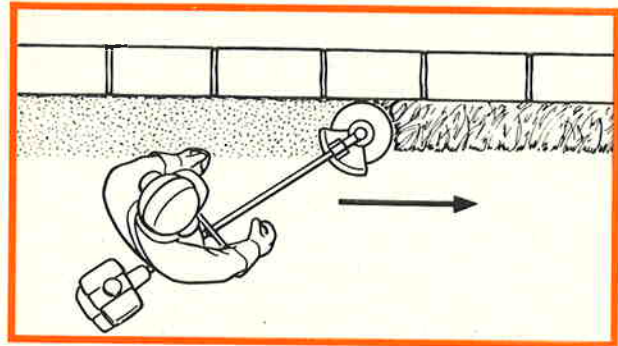

Sharpening is not necessary and worn cutting blades are easily replaced.

### Using the STIHL-"Rotocut 220"

The STIHL-"Rotocut 220" blade is made of high impact polymer and is used for cutting high growing grass, shrubs and bushes (not wood).

A high cutting rate is achieved by the eight molded blades. When these blades become dull, the "Rotocut 220" is simply turned over to produce eight fresh cutting edges.

Mowing with STIHL-“Rotocut 220”, STIHL-“Duocut”, STIHL-“Tricut”, grass cutting blade or bush knife 250

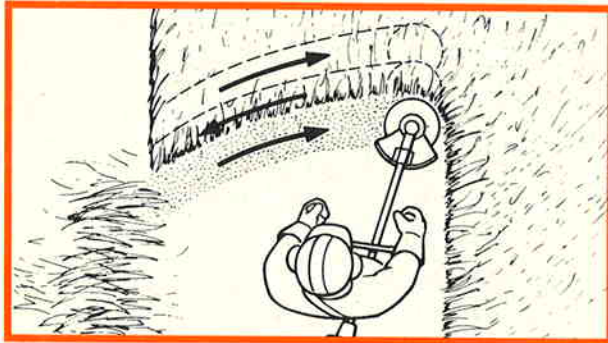

The Brushcutter is swept in an arc during cutting – similar to a scythe.

**Using the STIHL-“Duocut” and -“Tricut” (FS 61 E only)**

Both these polymer blades are suitable for cutting high growing grass.

The three-bladed STIHL-“Tricut” can also be used for clearing non-ligneous shrubs. In such applications the rotating cutting tool is brought down onto the growth from above. For mowing the Brushcutter should be swept in an arc like a scythe.

**Using the grass cutting blade (FS 61 E only)**

All kinds of grass, brush, weeds, shrubs etc. can be easily cut with the grass cutting blade. The Brushcutter is swept in an arc similar to a scythe.

The cutting blade has 4 cutting knives which are each equipped with cutting edges on both sides, i.e. front and rear. When the cutting edges become dull on one side the cutting blade need only be turned over and the tool is ready to cut again with 4 fresh cutting edges.

The blade has to be resharpened when all eight cutting edges are dull.

Cutting wild growth and scrub with the brush knife 250 or STIHL-“Tricut”

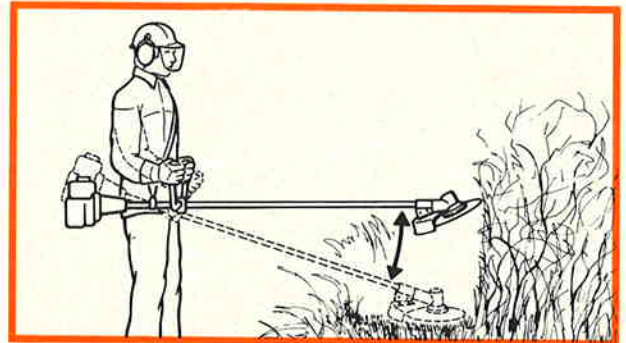

**Using the brush knife 250 (FS 61 E only)**

When fitted to the FS 61, the brush knife is suitable for applications ranging from cutting matted grass to clearing weeds, wild growth and scrub.

To cut wild growth and scrub, lower the rotating brush knife down onto the growth to achieve a chopping effect. Use the brushcutter like a scythe to cut grass, i.e. sweep it to and fro in an arc.

**Using the circular saw blade 200 (FS 61 E only)**

The circular saw blade 200 is used on the FS 61 for cutting woody wild growth and thick brush up to a diameter of max. 2 cm (3/4"). Thicker growth must not be cut because of the increased risk of accidents.

The engine should be run at full throttle and the cutting tool guided slowly and steadily like a scythe (do not hack at the growth).

## MAINTENANCE, REPAIR AND STORING

Use only STIHL replacement parts for maintenance and repair. Use of parts manufactured by others may cause serious or fatal injury.

Follow the maintenance and repair instructions in the appropriate section of your Owner's Manual.

### Warning!

Always stop the engine and make sure that the cutting tool is stopped before doing any maintenance or repair work or cleaning the Brushcutter. Do not attempt any maintenance or repair work not described on your Owner's Manual. Have such work performed at your STIHL service shop only.

### Warning!

Never repair damaged cutting attachments by welding, straightening or modifying the shape. This may cause parts of the cutting tool to come off and result in serious or fatal injuries.

Check condition of cutting tool at regular short intervals, if behavior of tool changes suddenly, check it immediately for any signs of cracks in particular. Replace damaged or dull cutting tools immediately, even if they have only superficial cracks.

Check fuel filler cap for leaks at regular intervals. Use the specified spark plug and make sure it and the ignition lead are always in good condition.

### Warning!

A worn or damaged muffler is a fire hazard and may cause loss of hearing. Check to see that the muffler is in good condition. The Brushcutter must not be operated if the

muffler is faulty or has been removed. Remember that the risk of forest fires is greater in hot weather. Use the fire-safe muffler supplied with the unit. Never touch a hot muffler or burn will result.

Keep cutting tool sharp. Tighten all nuts, bolts and screws except the carburetor adjustment screws after each use.

Keep spark plug and wire connection tight and clean. The spark plug electrode gap must be 0.6–0.7 mm and should be checked with a feeler gauge at least every 50 operating hours and reset if necessary. Fit a new spark plug if the electrodes are badly pitted.

Store Brushcutter with full fuel tank in a dry place ready for operation and away from children.

Before storing for longer than a few days always empty the fuel tank and protect the engine against corrosion. To do this, first remove filter cover, strainer and filter. Then spray corrosion inhibiting oil into the carburetor while stopping the engine. It is not necessary to flush the engine before restarting, i.e. it need only be filled up with fuel. If the engine does not start, take off filter cover and spray a little fuel into the carburetor.

## Assembling the Brushcutter

The Brushcutter is partly disassembled for ease of shipment and must be assembled before it can be used for the first time.

It should be noted that there are differences between the FS 61 E with two-handed handlebar and the FS 61 RE with loop handle.

**Warning:** Because of the increased risk of accidents the powerhead must not be started while it is detached from the Brushcutter.

### Mounting the powerhead

Position the powerhead against the Brushcutter housing in such a way that the support on the powerhead and the bearing housing at the curved end of the drive tube are pointing in the same direction. Then align the powerhead and Brushcutter so that the four holes line up. Now slip the lockwashers and plain washers onto the M 6x20 hex. head screws. Insert the screws and use a 10 mm open-end wrench to tighten them down securely in an alternate pattern.

### Mounting the loop handle (FS 61 RE)

First fit the split rubber sleeve (1) on the drive tube, about 30 cm in front of the rubber grip.

Unscrew the nuts from the screws in the clamp on the loop handle (2). Remove the hinge screw (3) and clamp screw (4) and place the loop handle on the rubber sleeve (1). Insert the hinge screw (3) in the clamp and secure it with a nut.

Finish off by aligning the loop handle and tightening it down securely with the clamp screw (4), lockwasher and nut.

Top: Tightening the hex. head screws  
Center: Rubber sleeve in position  
Bottom: Loop handle fitted

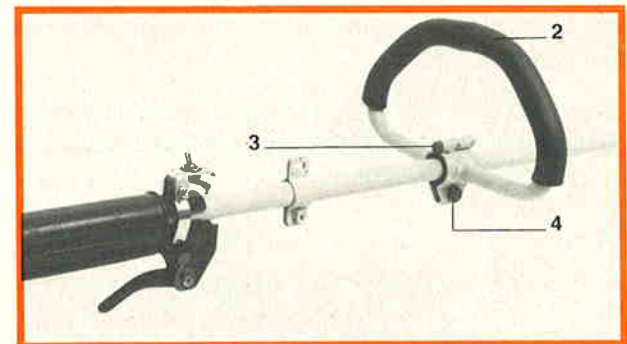
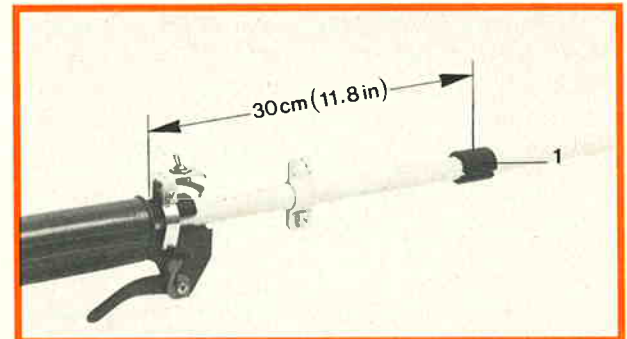

### Mounting the two-handed handlebar (FS 61 E)

First connect up the two halves of the handlebar on the hinge pin of the clamp.

Make sure that the grip ends of the handlebar curve forward toward the cutting tool end of the drive tube and then fit the handlebar about 30 cm below the rubber grip on the drive tube.

Fit the two spacer shells and line up the handlebar (bearing housing and deflector must face downward – the handlebar upward). Secure in position with M 8x20 screw, lock-washer and nut.

### Mounting the throttle control and stop switch (FS 61 E)

The throttle lever (1) and stop switch (2) are attached to the right-hand half of the handlebar (looking from the powerhead to the handlebar). Remove screw (3) and bend open the clamp. Slip it over the handlebar. Then use screw (3) to secure the stop switch to the clamp. Move the throttle lever and stop switch to the most convenient position and then tighten the clamp.

### Fitting the throttle cable (FS 61 E)

Pass the throttle cable (4) through the hole in the rubber grip. Then attach nipple (5) to throttle lever (1) and locate cable sleeve in seat provided in the throttle lever bracket.

**Important:** The throttle cable must not be kinked or laid in very tight bends.

Top: Handlebar in position  
Center: Throttle lever with stop switch  
Bottom: Attaching the throttle cable

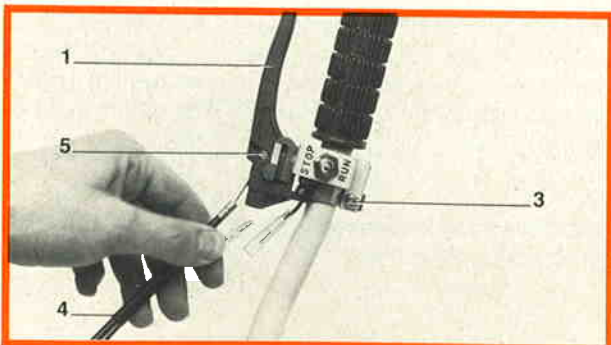
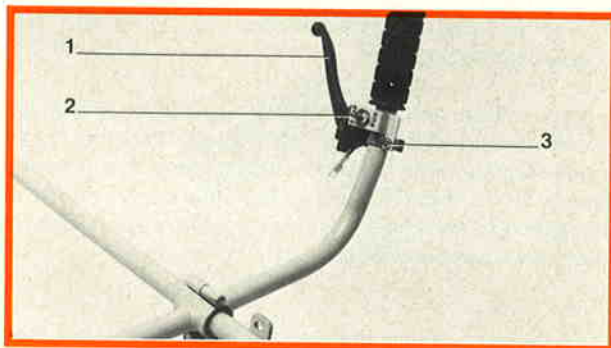
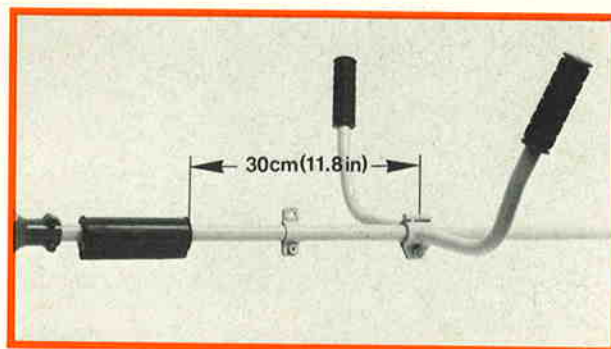



Attaching throttle cable nipple to throttle lever

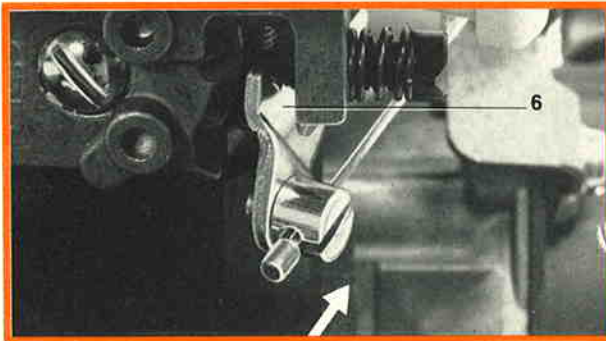

**Fitting and adjusting the throttle cable on the carburetor (all versions)**

Engage the free end of the throttle cable in the slotted pin on the carburetor's throttle lever (6) so that the nipple slides into the bore in the pin. Then place the threaded sleeve of the throttle cable in the retainer (7). The two hexagon nuts must be on either side of the retainer. Tighten them down temporarily by hand.

The two hexagon nuts are used for final adjustment of the throttle cable. Now set the throttle cable by turning the hexagon nuts until the carburetor's throttle lever butts against the idle adjustment screw (8) when the throttle control on the handlebar is in the idle position. In the full-throttle position the carburetor's throttle lever must butt against the stop on the carburetor body.

Once the setting is correct, tighten down the hexagon nuts securely (10 mm wrench).

Top: Screw sleeve of throttle cable fitted in retainer  
Center: Throttle lever butts against idle adjusting screw  
Bottom: Throttle lever butts against carburetor body

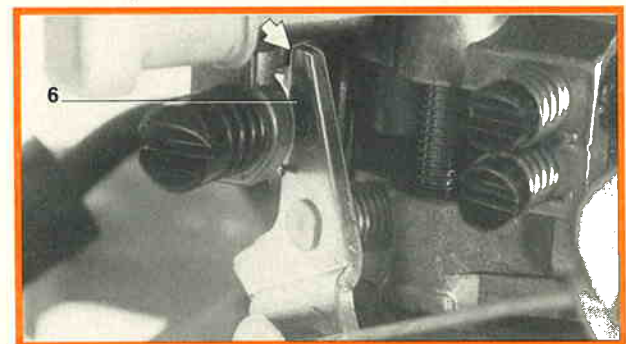
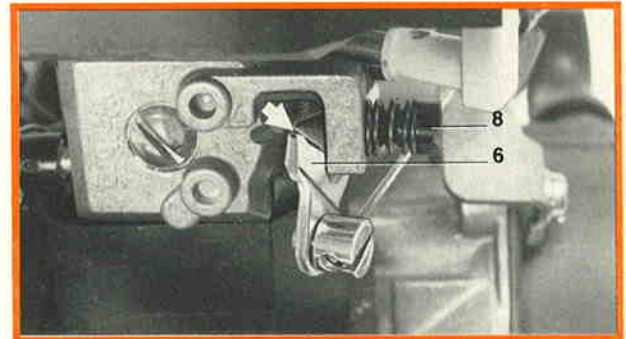
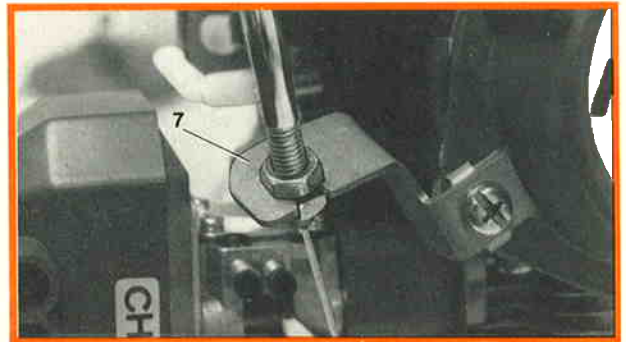

### Connection of stop switch lead (FS 61 E and FS 61 RE)

Insert the stop switch lead (9) – it is attached to the throttle cable – in the spare connection of the twin plug connector (10) and the plug connector at the stop switch.

The plug connections of the stop switch lead must be secure and make good contact since proper operation of the stop switch is dependent on them.

### Mounting the deflector

First open up the two ends of the bracket (1) and fit it over the drive tube. Put one lockwasher on each of the M 6x16 hex. head screws and screw them temporarily into the bracket.

After fitting the shim (2) on the inside of the guard (3), line up the guard on the bracket. Insert the M 5x14 screws through the holes in the guard and bracket (from inside outward), fit the lockwashers and nuts and tighten securely.

Now slide bracket on drive tube down to bearing housing and turn it so that the collar of the deflector engages in the recess on the housing guard ring. Finally tighten hex. head screws in bracket.

Top: Stop switch lead connected  
Center: Bracket fitted on drive tube  
Bottom: Deflector fitted in position

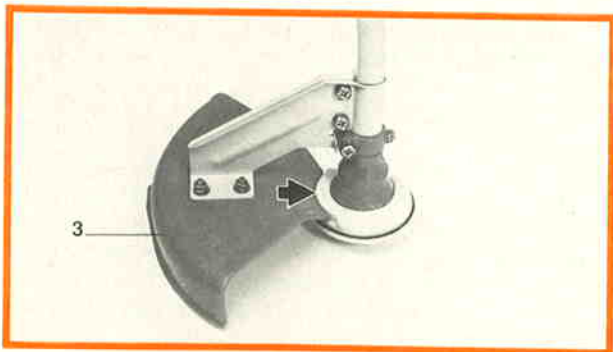
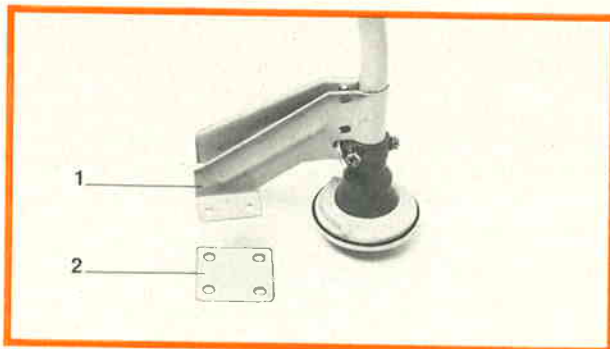

## Fuel

Fuel filler cap removed

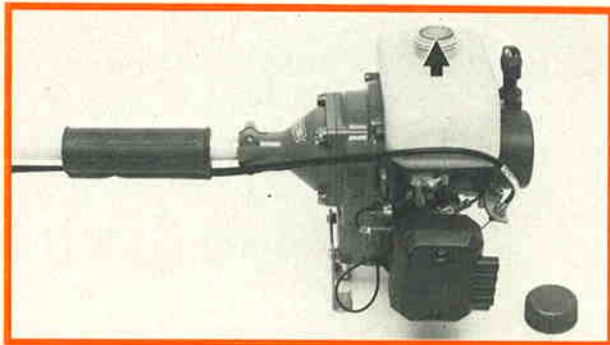

Your two-stroke engine requires a mixture of gasoline and engine oil.

Use regular grade gasoline with a minimum octane number of 90 ROZ. If the octane number of the regular grade gasoline in your area is lower, you may also use a higher grade gasoline.

Should you use gasoline with an octane number below 90 ROZ, it may result in preignition (causing "pinking") which is accompanied by an increase in engine temperature. This in turn increases the risk of the piston seizing and damaging the engine.

Apart from the octane number, the chemical composition of the fuel is also important. Some fuel constituents not only detrimentally affect elastomers (carburetor diaphragms, oil seals, fuel lines etc.) but magnesium castings as well. This may result in problems in operation as well as damage to the fuel tank. For this reason it is essential that you use only branded gasoline.

Only use STIHL two-stroke engine oil or other branded two-stroke engine oils for mixing. The mix ratio is 1:40 (1 part oil to 40 parts gasoline) when you use STIHL two-stroke engine oil or 1:25 for other branded two-stroke engine oils.

Table of fuel mixes:

Gasoline	Engine oil for 1:25 mix	Engine oil for 1:40 mix
Liters (gal.)	Liters (pt.)	Liters (pt.)
5 (1)	0.2 (1/3)	0.125 (1/8)
10 (2)	0.4 (2/3)	0.25 (2/8)
15 (3)	0.6 (1)	0.375 (3/8)
20 (4)	0.8 (1 1/3)	0.5 (4/8)
25 (5)	1.0 (1 2/3)	0.625 (1)

**Note:** A fuel mixture that has been left standing for a prolonged period will begin to separate. For this reason you should thoroughly shake the mixture in the can before fueling.

Before refueling, carefully clean the filler cap and the area around it to ensure that no dirt falls into the tank.

## Mounting the cutting tools

To mount or change the cutting tool, position the Brushcutter so that its gear head is facing upward.

Now hold the thrust washer with the 36 mm open-end wrench and use the socket wrench to release and remove the hex. head screw clockwise (left-hand thread). Take off the thrust washer.

The cutting tool can now be fitted and firmly secured in position.

The **following cutting tools** are approved for the **FS 61 E** (with two-handed handlebar):

- 1 STIHL "Polycut" mowing head
- 2 STIHL "Polymatic" nylon line head
- 3 STIHL "Rotocut 220" (polymer)
- 4 STIHL "Duocut" (polymer)
- 5 STIHL "Tricut" (polymer)
- 6 Grass cutting blade (steel)
- 7 Brush knife 250 (steel)
- 8 Scratcher tooth circular saw blade 200 (steel)

### Warning!

**Only the cutting tools listed below** are authorized to be fitted on the **FS 61 RE** Brushcutter (with loop handle). The use of any other polymer or metal cutting tools may cause serious injury if they come in contact with the operator:

- 1 STIHL "Polycut" mowing head
- 2 STIHL "Polymatic" nylon line head
- 3 STIHL "Rotocut 220" (polymer)

Top: Releasing the hex. head screw  
Center: Thrust washer removed  
Bottom: Cutting tools for FS 61 E/61 RE

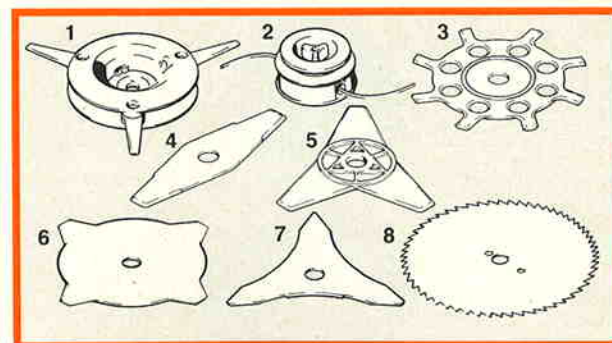
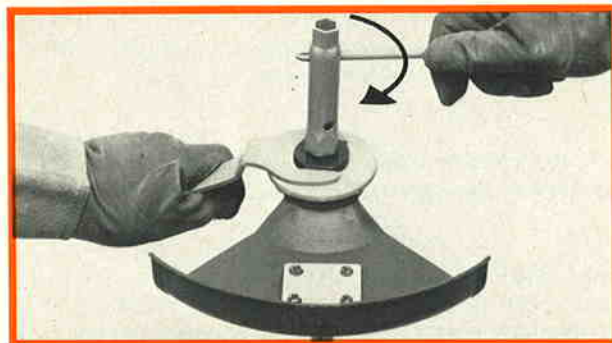

## STIHL "Polycut" head

There is a metal ring (2) in the mowing head's (1) center mounting hole. It is only required on larger STIHL Brush-cutters from model FS 150 onward.

The ring must be removed for the FS 61 E/61 RE. This is best done with a screwdriver.

Now place the flat side of the mowing head (1) on the thrust plate (3). Slip the thrust washer (4) over the shaft (5) so that its shoulder is facing away from the mowing head.

Screw the hex. head screw (7) with washer (8) into the shaft (5) and use the socket wrench to tighten it down counter-clockwise. Hold the mowing head firmly while tightening the screw.

Top: Removing the metal ring  
Center: Correct assembly sequence  
Bottom: Tightening the hex. head screw

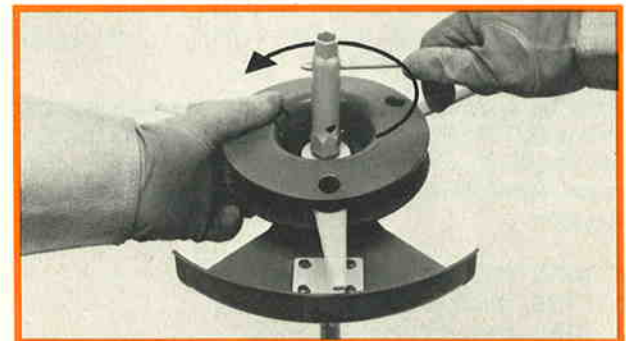
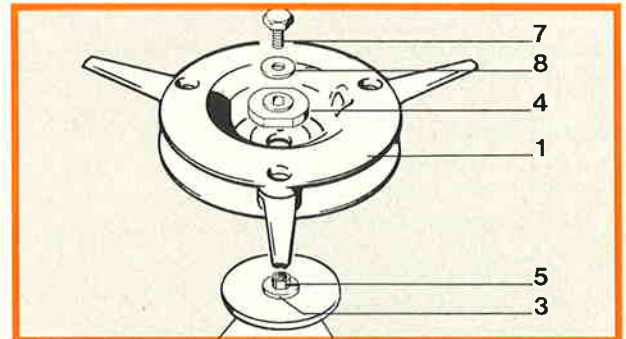

## STIHL "Polymatic" nylon line head

To fit the nylon line head on the FS 61 E/61 RE, first place the washer (2) – supplied with the head – on the guard ring (6).

Slip the thrust washer (4), shoulder must face away from bearing housing, onto the shaft (5).

Now screw thread of nylon line head (1) counterclockwise (left-hand thread) into the shaft (5) as far as it will go.

As the nylon line head has a left-hand thread it tightens up automatically during operation, i.e. no further tightening is necessary.

To remove the nylon line head, hold the thrust washer (4) steady with the 36 mm open-end wrench and then slacken off and unscrew the nylon line head clockwise.

Top: Washer in position  
Center: Correct assembly sequence  
Bottom: "Polymatic" nylon line head fitted

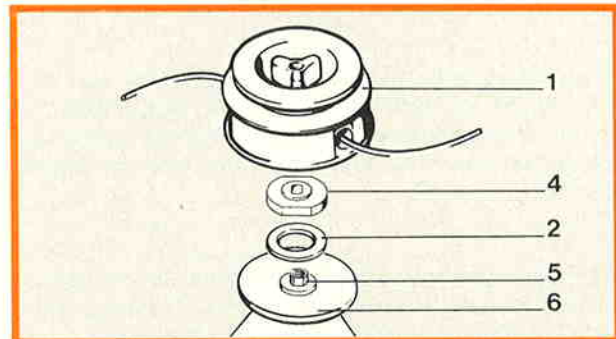
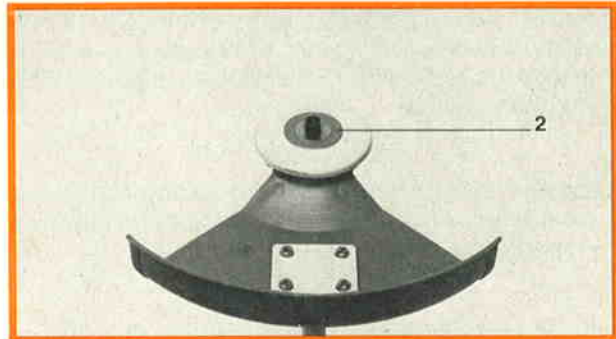

## STIHL "Rotocut 220"

The STIHL "Rotocut 220" mounting kit is supplied with a rider plate and a spacer washer. The spacer washer is not required for mounting the "Rotocut 220" to model FS 61 E/61 RE Brushcutters.

Place the "Rotocut 220" (1) on the guard ring (6). The Rotocut may be fitted either way round and is centered by the raised collar of the thrust plate (3).

Now slip the thrust washer (4) over the shaft (5) so that its shoulder faces away from the cutting tool.

Fit the rider plate (9) on the thrust washer (4) and then screw home the hex. head screw (7) with washer (8) counterclockwise (left-hand thread). Hold the cutting tool and tighten down the hex. head screw with the socket wrench.

The rider plate keeps the cutting tool at a minimum distance from the ground during cutting. This reduces the risk of the rotating cutting tool touching the ground.

Top: Rotocut on guard ring  
Center: Correct assembly sequence  
Bottom: STIHL "Rotocut 220" mounted ready for use

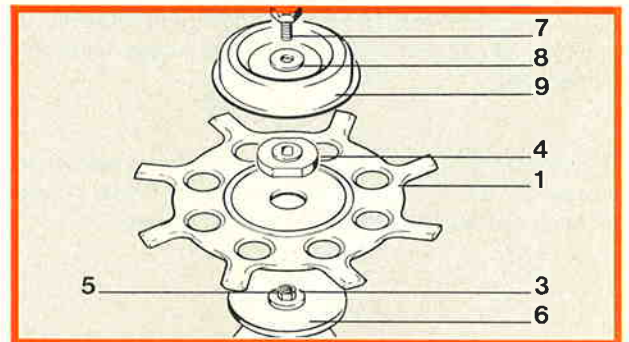
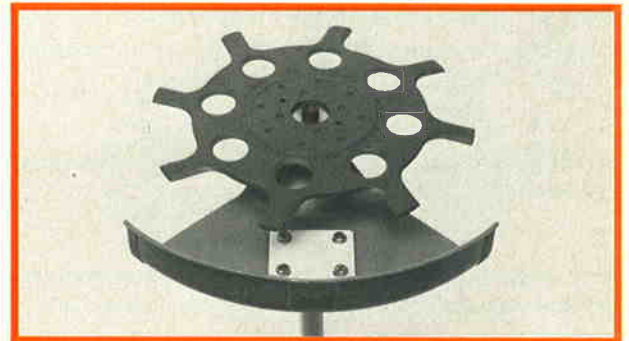

**Grass cutting blade, brush knife 250,  
circular saw blade 200 (FS 61 E only)**

Top: Grass cutting blade in position  
Bottom: Brush knife 250 in position

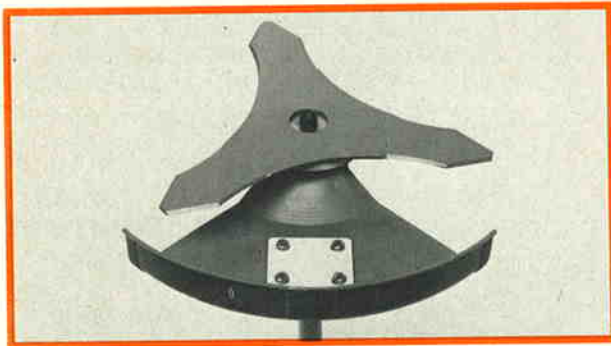
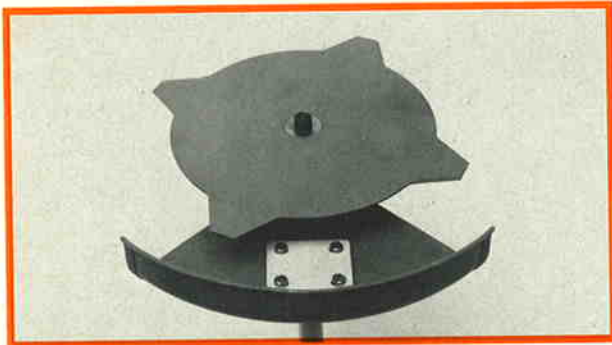

**Warning!**

The steel cutting tools – grass cutting blade, brush knife 250 and circular saw blade 200 – may only be fitted to machines with a two-handed handlebar (FS 61 E) and **not to machines with a loop handle** (FS 61 RE). The use with a FS 61 RE may cause serious injury if they come in contact with the operator.

Place the tool on the guard ring (6). It is centered by the raised collar of the thrust plate (3).

**Important:** The cutting edges of the circular saw blade 200 must point in the clockwise direction. The brush knife 250

Correct assembly sequence

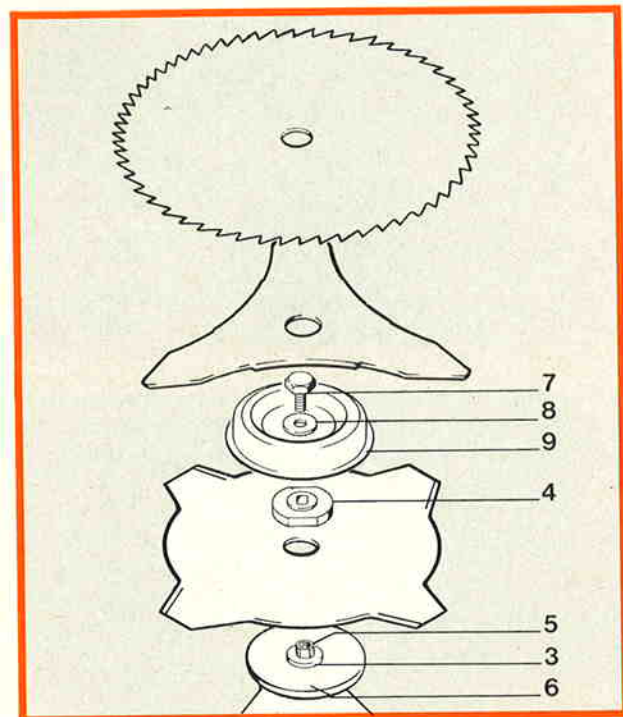

and grass cutting blade may be installed either way round.

Now fit the thrust washer (4) over the shaft (5) so that its raised collar faces away from the bearing housing. After fitting the rider plate (9) on the thrust washer (4), screw home the hex. head screw (7) with washer (8) counterclockwise (left-hand thread). Hold the cutting tool (wear gloves) and use the socket wrench to firmly tighten down the screw.

The circular saw blade 200 is fitted without the rider plate. When tightening down the hex. head screw, use a 36 mm open-end wrench to counterhold the thrust washer.



## Fitting the harness – balancing the Brushcutter

Harness fitted



The harness supplied with the Brushcutter must be worn over the left shoulder so that the spring hook hangs at the right hip after its length has been suitably adjusted.

The Brushcutter must be properly balanced after you attach the spring hook to the carrying ring on the drive tube. This is done by slackening the M 6 hex. head screw on the clamp and moving the carrying ring along the drive tube.

If you are using a mowing or "Polymatic" nylon line head (STIHL "Polcut", "Polymatic") or one of the tools fitted together with the rider plate (STIHL "Rotocut 220", STIHL "Duocut" STIHL "Tricut", grass cutting blade, brush knife 250), balance the Brushcutter so that the cutting tool or rider plate rests on the ground when you let go of the handle.

In the case of the circular saw blade 200 which is mounted without the rider plate, balance the Brushcutter so that the cutting tool stays about 30 cm (1 ft) clear of the ground when you let go of the handles.

Top: Moving carrying ring  
Center: Balanced with ground contact  
Bottom: Balanced about 30 cm (1 ft) from ground



## Starting (FS 61 E)

Fuel tap open

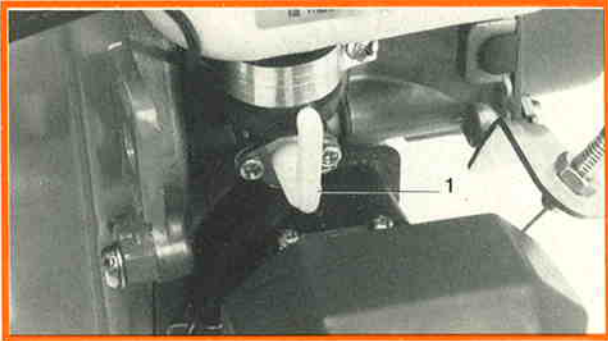

To start, place the Brushcutter on a clear patch of ground – allow it to rest on the engine support and the deflector. Make sure you have a firm foothold, keep a firm grip on the machine and check that the cutting tool is clear of the ground and any other obstructions.

### Starting procedure

1. Open the fuel tap by setting lever (1) to vertical position.
2. Flick stop switch (2) to “RUN” position.
3. Always start a **cold engine** with the choke closed. Turn choke lever (3) to “CHOKE”.  
Start a **warm engine**, or one that has only been stopped for a short period, with the choke open. Turn choke lever (3) away from “CHOKE”.
4. Set throttle control lever to starting-throttle position. To do this, squeeze throttle control (4) until the starting-throttle latch (5) can be pressed in. Now release throttle control (4) first and then the starting-throttle latch (5) – the throttle control lever will stay in the starting-throttle position.

Top: Stop switch on “RUN”  
Center: Choke lever on “CHOKE”  
Bottom: Throttle lever in start position

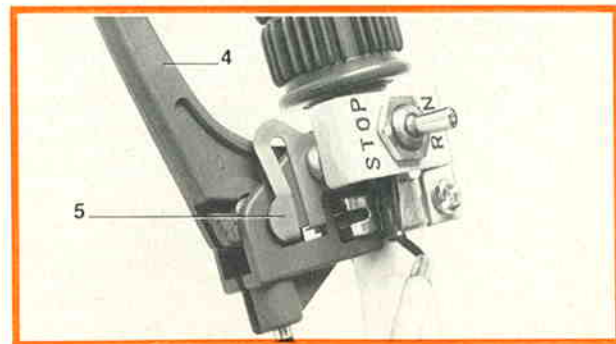
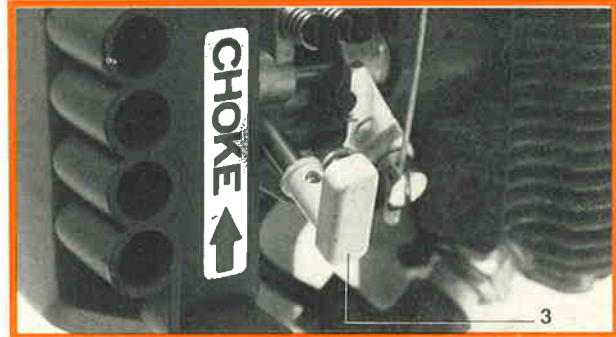
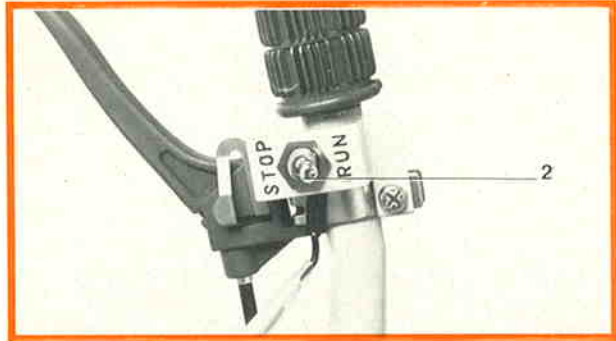

Starting



5. To start, hold Brushcutter firmly with your left hand on the rubber grip. Pull starter grip slowly with your right hand until to feel a definite resistance and then give a brisk strong pull, but do not pull out starter rope more than about 70 cm (27 in) as there is otherwise a risk of breaking it.

Do not allow starter rope to snap back. Guide it slowly back into the housing so that it can rewind correctly.

Repeat starting procedure until engine begins to fire. Then open choke immediately (choke lever away from "CHOKE" and continue cranking.

6. Once the engine is running, release starting-throttle latch (5) by briefly squeezing throttle control lever (4) so that engine can settle down to idle speed.
7. To stop the engine, move stop switch (2) to "STOP" position and close the fuel tap (1).

**26** See notes on page 29.

Top: Throttle lever in idle position  
Center: Stop switch on "STOP"  
Bottom: Fuel tap closed

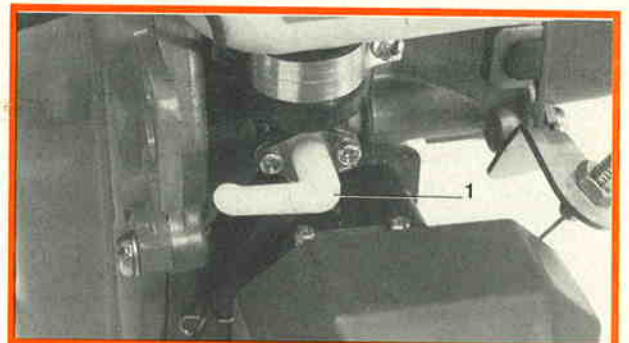
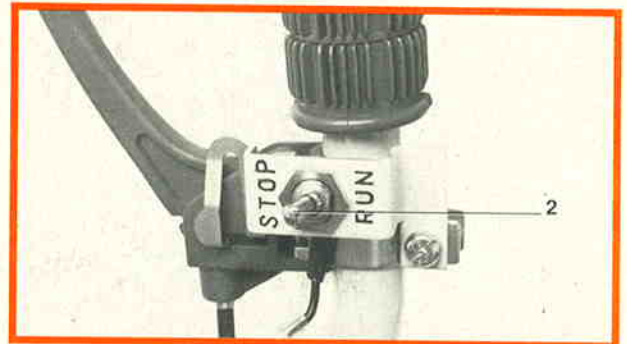
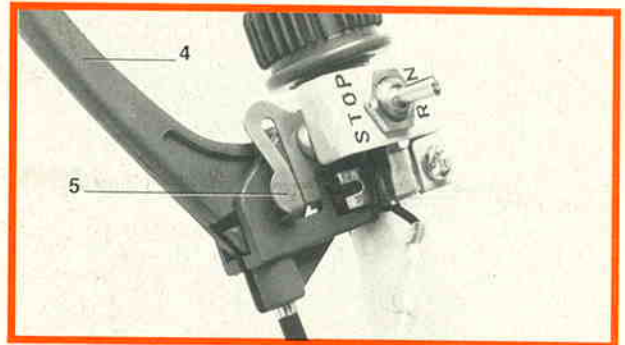

## Starting (FS 61 RE)

Fuel tap open

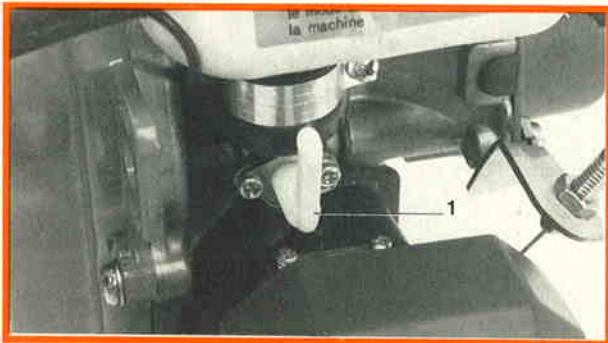

To start, place the Brushcutter on a clear patch of ground – allow it to rest on the engine support and the deflector. Make sure you have a firm foothold, keep a firm grip on the machine and check that the cutting tool is clear of the ground and any other obstructions.

### Starting procedure

1. Open the fuel tap by setting lever (1) to vertical position.
2. Flick stop switch (2) to "RUN" position.
3. Always start a **cold engine** with the choke closed. Turn choke lever (3) to "CHOKE".  
Start a **warm engine**, or one that has only been stopped for a short period, with the choke open. Turn choke lever (3) away from "CHOKE".
4. Set throttle control lever to starting-throttle position. To do this, squeeze throttle control (4) until the starting-throttle latch (5) can be pressed in. Now release throttle control (4) first and then the starting-throttle latch (5) – the throttle control lever will stay in the starting-throttle position.

Top: Stop switch on "RUN"  
Center: Choke lever on "CHOKE"  
Bottom: Throttle lever in start position

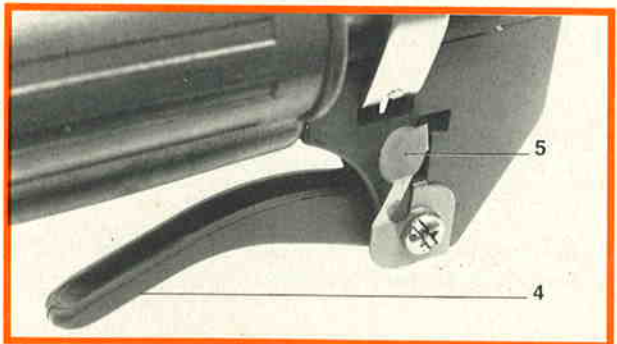
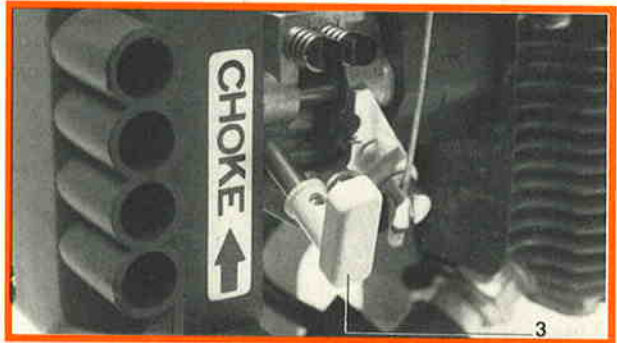
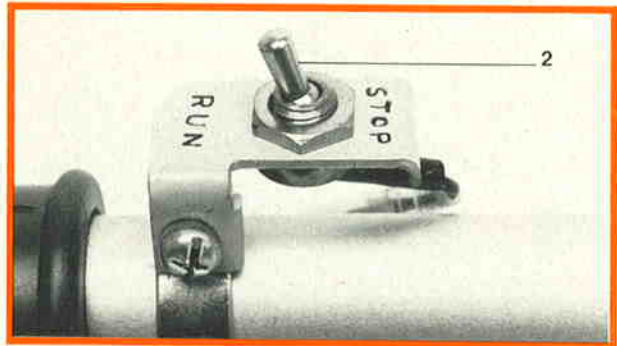

### Starting



5. To start, hold Brushcutter firmly with your left hand on the rubber grip. Pull starter grip slowly with your right hand until to feel a definite resistance and then give a brisk strong pull, but do not pull out starter rope more than about 70 cm (27 in) as there is otherwise a risk of breaking it.

Do not allow starter rope to snap back. Guide it slowly back into the housing so that it can rewind correctly.

Repeat starting procedure until engine begins to fire. Then open choke immediately (choke lever away from "CHOKE" and continue cranking.

6. Once the engine is running, release starting-throttle latch (5) by briefly squeezing throttle control lever (4) so that engine can settle down to idle speed.
7. To stop the engine, move stop switch (2) to "STOP" position and close the fuel tap (1).

**28** See notes on page 29.

Top: Throttle lever in idle position  
Center: Stop switch on "STOP"  
Bottom: Fuel tap closed

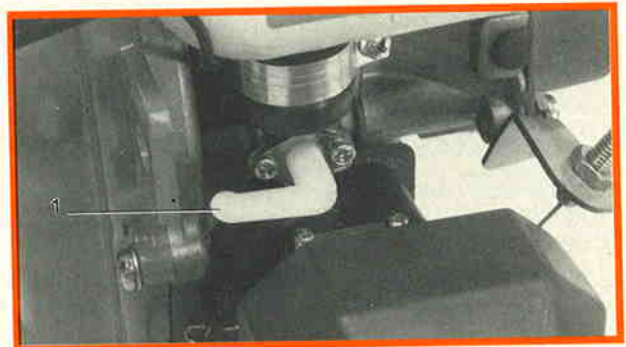
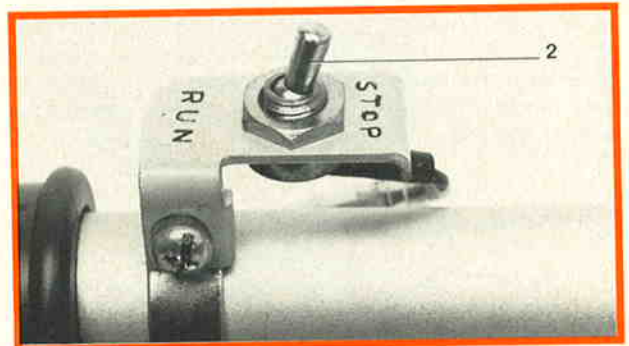
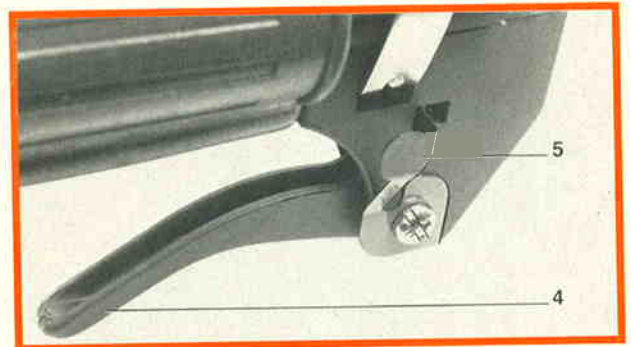

**Other points to be observed when starting the engine:**

When starting a cold engine only keep the choke closed until the engine begins to fire. Then open choke fully (choke lever away from "CHOKE"), even if the engine stops and you have to repeat the starting procedure. If the choke is left closed, the combustion chamber will flood and stall the engine.

In very cold weather only open the choke half way after starting. Allow engine to warm up for a brief period using a little throttle (release the starting-throttle latch). Then let go of throttle control lever and open the choke fully (choke lever away from "CHOKE").

If you opened the choke as soon as the engine began to fire and the engine does not start after several attempts, it is already flooded. If this is the case, remove and dry off the spark plug. With the spark plug still removed, move stop switch to "STOP", then open throttle fully and crank engine over on starter to clear the combustion chamber.

A new engine or one which has been run until the fuel tank is dry will not start first time after refueling because the carburetor's diaphragm pump has to be primed with fuel by cranking the engine over several times on the starter.

## Carburetor

- 1 = High speed adjusting screw H
- 2 = Low speed adjusting screw L
- 3 = Idle speed adjusting screw LA

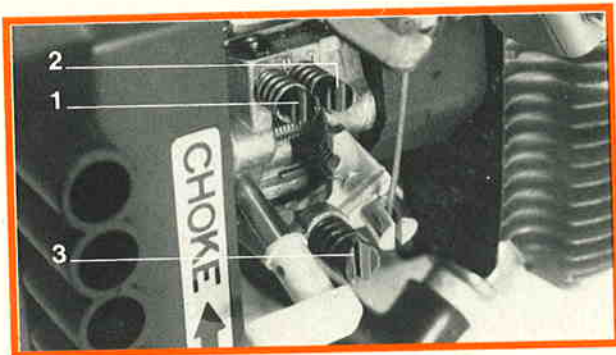

When the engine is tested at the factory the carburetor is set to obtain a slightly richer mixture to ensure that the cylinder bore and the bearings receive additional lubrication during the break-in period. This setting should be left as it is for the first three tank fillings. The high speed adjusting screw may then be turned no more than  $\frac{1}{4}$  turn clockwise (leaner mixture). Caution: The engine's maximum permissible r.p.m. must not be exceeded!

If you use your Brushcutter at high altitudes (mountains) or at sea level it may be necessary to change the carburetor setting slightly. Carry out the correction at the two adjusting screws (L and H) as follows: Turn clockwise (leaner) for high altitude operation or counterclockwise (richer) for operation at sea level.

Note that even slight alterations on the adjusting screws have a noticeable effect on the engine's running behavior. Only carry out carburetor adjustments after cleaning the air filter and warming up the engine.

**Caution:** Adjustment of the high speed adjusting screw not only affects the power output but also the maximum off-load engine speed. If the setting is too lean (screw turned too far clockwise), the maximum permissible

engine speed will be exceeded. This can cause engine damage, brought about by lack of lubrication and overheating in particular. Corrections to the setting of the high speed adjusting screw may be carried out only if an accurate tachometer is available to check the maximum engine speed of 9,000 r.p.m. (with cutting tool). Moreover, a cutting tool with a low drag coefficient (e.g. grass cutting blade or brush knife 250 on the FS 61 E; STIHL "Rotocut 220" on the FS 61 RE) should be fitted for the adjustment.

### Basic setting

If it is necessary to readjust the carburetor again from the beginning, first carry out the basic setting to obtain a starting point for fine adjustment. To do this, carefully screw the two adjusting screws down onto their seats (clockwise). Then make the following adjustment:

- High speed adjusting screw H:** back off  $1\frac{1}{8}$  turn
- Low speed adjusting screw L:** back off 1 complete turn

If you have no means of checking the maximum engine speed, do not set the high speed adjusting screw any leaner by turning it beyond the basic setting.

### Notes for adjusting idle speed

#### Engine stops while idling

Turn idle speed adjusting screw (LA) clockwise until cutting tool begins to rotate. Then back off one half turn. The cutting tool must not rotate.

### Cutting tool rotates when engine is idling

Turn idle speed adjusting screw (LA) counterclockwise until cutting tool stops rotating and then turn it another one half turn.

### Erratic idling behavior; poor acceleration

Idle setting too lean; turn low speed adjusting screw (L) counterclockwise until engine runs and accelerates smoothly.

### Exhaust smokes at idle speed

Idle speed setting too rich; turn low speed adjusting screw (L) clockwise until engine speed drops. Then turn screw back one quarter turn and check that engine still accelerates smoothly when you open the throttle.

A correction at the low speed adjusting screw usually necessitates a change in the setting of the idle speed adjusting screw (LA).

Apart from minor readjustments, you should leave all carburetor setting and repair work to your STIHL dealer. STIHL dealers have trained staff and all the necessary servicing tools and equipment.

## Air filter

Component parts in correct assembly sequence

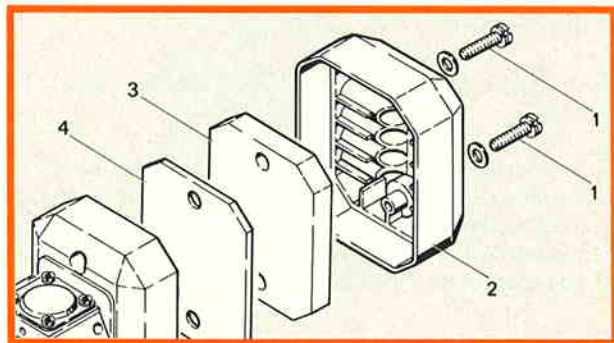

**The air filter must therefore be cleaned when engine power begins to drop off.**

The purpose of an air filter is to prevent the dust and dirt in the intake air from entering the carburetor. It thus helps reduce wear on the engine components to a minimum.

Clogged air filters reduce engine power, increase fuel consumption and make starting more difficult.

**The air filter must therefore be cleaned when engine power begins to drop off.**

Before removing the filter, close the choke (choke lever to "CHOKE") to stop dirt getting into the carburetor. Remove the screws (1) and take off the filter cover (2), foam element (3) and felt element (4).

Wash foam element in clean gasoline and dry it. Clean the felt element by knocking it on the palm of your hand or blowing it out with compressed air. Renew element if it is heavily loaded.

Never refit a damaged filter element, always fit a new one. Install air filter assembly in the reverse sequence. When fitting the filter cover, make sure that the intake openings point toward the starter mechanism.



## Repair of cutting tools

### Replacing STIHL "Polycut" blades

Each blade is supported by a needle sleeve on a collar screw (1).

To change blades, unscrew the collar screw (1) with the screwdriver end of the combination wrench, making sure you do not lose the hexagon nut (2). Use a suitable tool (e.g. punch) to press the collar screw out of the blade and bottom part of the "Polycut" head.

The blade can now be taken out of the "Polycut" head.

Check freedom of movement of needle sleeves before reassembling. If they are stiff, wash the collar screws (1) in clean gasoline and oil the needle sleeves.

If a used blade is refitted, always make sure it is fitted in the same position as before.

Retighten collar screws after a brief period of operation (about 3–5 minutes).

It is advisable to keep new polymer cutting blades in a water bath until you use them for the first time. This also applies to blades that are not used for long periods. This method of storage increases the toughness and edge life of polymer cutting blades.

### Replacing nylon line on STIHL "Polycut" head

Remove remaining nylon line from mowing head. Cut a length of line about 400 mm (16 in) long. Fold line so that you have two equal lengths and then make a loop. Fit loop over lug from above and thread the two ends through the holes in the sides of the "Polycut" head (from inside outward).

Top: Blade bearing  
Center: Removing worn blades  
Bottom: Fitting nylon cord

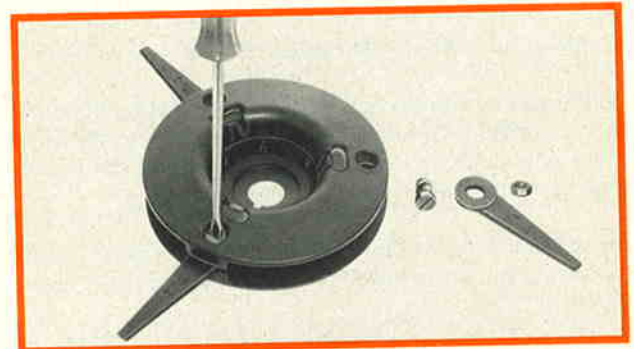
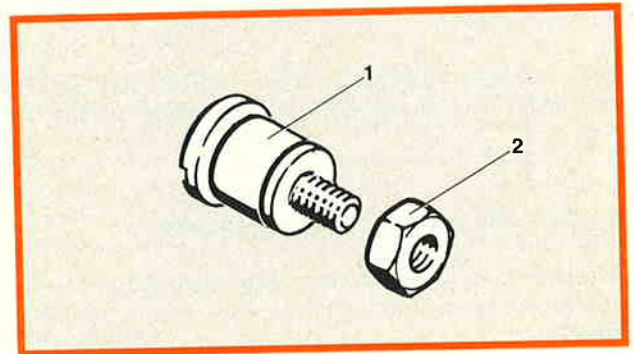

Rotating the cord magazine



#### Adjusting nylon cord on "Polymatic" nylon line head

If the ends of the nylon cord become frayed to such an extent that cutting performances decreases noticeably, the nylon cord must be adjusted.

To do this, hold outer drum of attachment with one hand and, with other hand, pull cord magazine out of drum until the pegs are clear of the holes.

Now rotate cord magazine counterclockwise (looking at thumb nut) until nylon cord can be pulled out to a length of 12–15 cm (5"–6" – depending on Brushcutter power). Then allow cord magazine to spring back and turn it so that the pegs engage in the holes.

This procedure can be repeated until the cord magazine is empty, i.e. nylon cord cannot be pulled out to correct length. The cord magazine must then be refilled.

Fitting the cord magazine



#### Replacing nylon cord on "Polymatic" nylon line head

First unscrew thumb nut and withdraw the cord magazine from the outer drum and pull the ends of the cord out through the metal sleeves. Remove remaining nylon cord from the magazine.

Cut about 5 m (16 ft) of cord from the 15 m (50 ft) spool (the spool is sufficient for about three refills) and thread it through the two holes in the hub of the cord magazine.

You should now have two equal lengths of cord. Hold both lengths together and wind them round the hub in the direction shown by the arrow. Thread the ends of the nylon cord through the metal sleeves and then push the cord magazine into the drum so that the pegs engage in the holes.

Now fit helical spring, screw the thumb nut onto the stud and tighten it down firmly.

The nylon cord can now be adjusted to the required length.

### STIHL-“Duocut” and -“Tricut” Blades

The STIHL-“Duocut” and -“Tricut” polymer cutting blades are not resharpened.

If the cutting edges become worn or nicked, the complete blade must be replaced.

### Reworking the STIHL-“Rotocut 220”

It is possible to rework the “Rotocut 220” when the cutting edges of the molded blades become dull or break away.

This is done by cutting through to the eight holes, as shown in the illustration, to produce eight fresh blades.

Once these cutting edges become dull on both sides, the “Rotocut 220” is due for replacement.

### Sharpening the Circular Saw Blade 200

In the case of minor blemishes or normal dull teeth, the circular saw blade 200 can be resharpened with the triangular file, 0811 421 8971.

However, in the case of more advanced signs of wear it is necessary to sharpen the saw blade on an automatic grinding machine.

Your STIHL Service Shop will give you all the necessary details.

Top: Worn STIHL-“Rotocut 220”  
Center: Reworked STIHL-“Rotocut 220”  
Bottom: Filing the circular saw blade

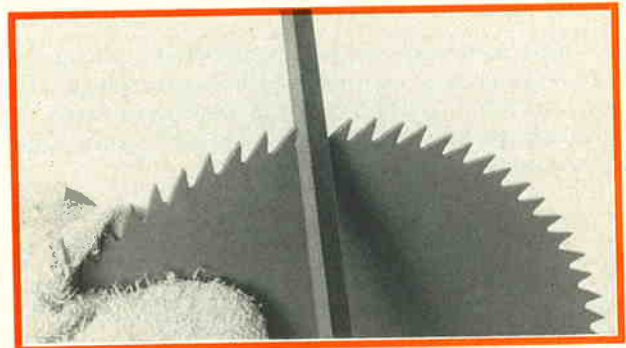
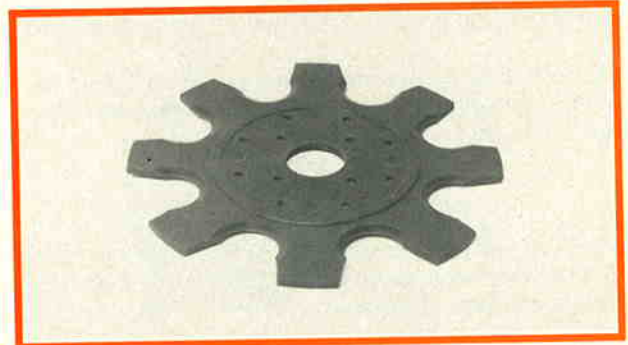

## Sharpening the grass cutting blade

- 1 Cutting edges
- 2 Cutter
- 3 Blade body

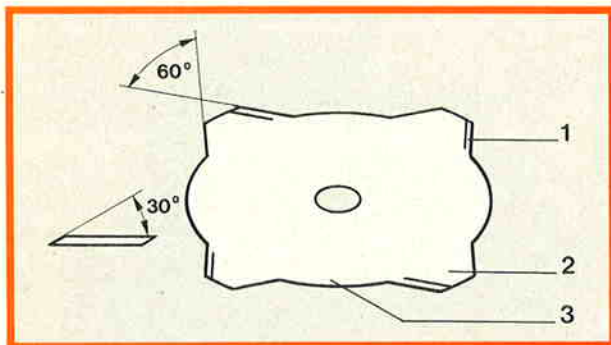

The cutting edges should not be sharpened until the blade has been turned and all eight cutting edges are dull. This is important in order to help avoid the cutting tool becoming warped.

Only the cutting edges on the cutters are sharpened. The contour of the blade body must not be altered in any way.

When the cutting edges are just slightly dull they can be resharpened with a few strokes of the file (flat file 0814 212 3310). However, in the case of more serious wear or nicked cutting edges a grinder may be used.

In any event a filing angle of 30° should be maintained on the cutting edges and an angle of 60° on the cutters (see illustration). In order to avoid out-of-balance it is necessary to ensure that all four cutters are exactly the same size.

**Warning!** For safety reasons a bent or cracked grass cutting blade must neither be straightened nor welded (risk of breakage!).

## Sharpening the brush knife 250

Filing a cutting edge

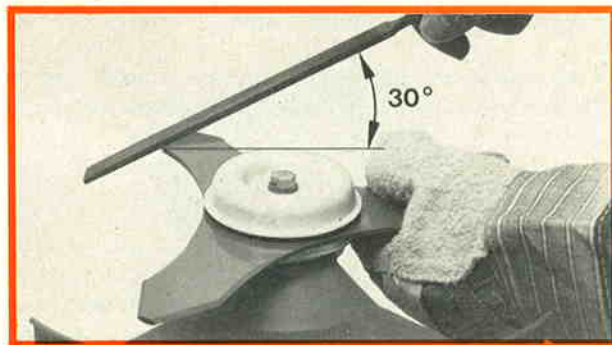

The brush knife 250 can be sharpened either while it is still on the Brushcutter or clamped in a vice.

Only sharpen the cutting edges at the pointed tips. It is not necessary to resharpen the curved cutting edges even if they are nicked in places.

A few strokes of a flat sharpening file (0814 212 3310) will be sufficient to restore the cutting edge if it is just slightly dull. If the cutting edges are blunt or chipped it will be necessary to file back all the tip cutting edges by the same amount. A grinder can also be used for this purpose. A symmetrical sharpening angle of 30° must always be maintained.

In order to avoid out-of-balance all the tips of the brush knife 250 must have the same shape after sharpening. This can be checked with the sharpening template enclosed with the pack.

**Warning!** For safety reasons a bent or cracked brush knife 250 must not be repaired!

## Rewind starter

### Replacing a broken starter rope

First release and unscrew the M 5x10 screws from the starter cover. Take off retainer for throttle cable and the starter cover.

Unscrew flat head screw (1) from starter post and take out cup washer (2) together with pawl (3) and torsion spring (4). The rope rotor (5) can now be pulled very carefully off the starter post. This must be done carefully because the inner loop of the rewind spring (6) has to slip out of the rope rotor. If resistance is felt during this process, turn rope rotor slightly counterclockwise while pulling it.

If the rope rotor (5) is not removed carefully, there is a risk of the spring loop sticking in the rope rotor and jumping out of its seat in the starter cover. If this happens, refit rewind spring (6) in starter cover as described under "Replacing a broken rewind spring".

Remove rope residue from rope rotor (5), thread a new 2.5 mm dia. and 900 mm long starter rope through the rope rotor and secure it with a simple knot. Pull rope so that the knot locates in the recess provided in the rope rotor (5). Insert other end of the rope through hole in starter cover and through the underside of the starter grip (7). Secure rope with a double knot. Wind starter rope clockwise (looking at top of rotor) onto the rope rotor (5) until about 20 cm is left between it and the starter grip.

36

Top: Removing mounting screws  
Center: Removing flat head screw from starter post  
Bottom: Component parts in correct order

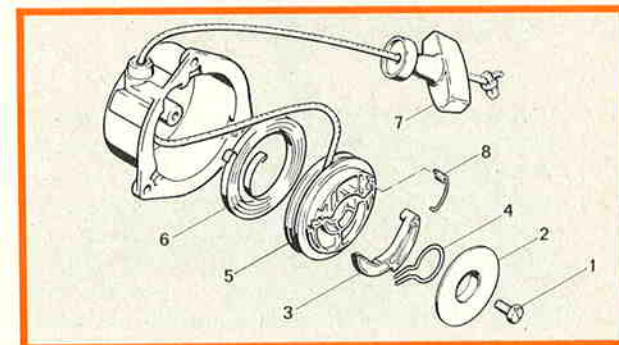
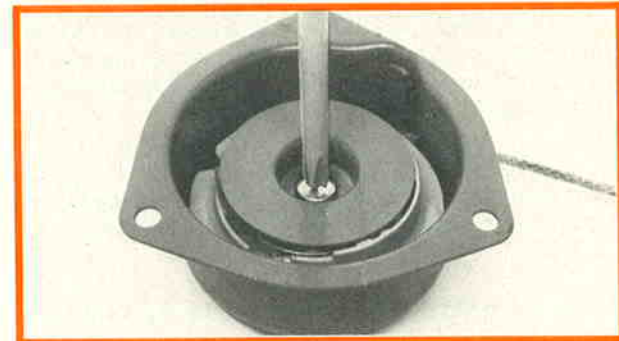

If the rewind spring (6) is new or has been refitted, check the position of the inner spring loop and correct as necessary before fitting the rope rotor (5). The loop should be about 2 mm from the starter post.

Now fit torsion spring (8) in rope rotor (5). Coat bore of rope rotor with resin-free oil and then position rotor on starter post so that the inner spring loop slips onto the lug in the rotor.

The starter rope should be placed in the groove of the rope rotor at the same time. Check whether spring loop is properly engaged by turning the rope rotor clockwise – it should then spring back.

Fit cup washer (2) with torsion spring (4) and pawl (3) on the rope rotor (5). Insert bearing pin of pawl in hole in rope rotor and bend long leg of torsion spring (8) outward until the pawl fits past it. Refit flat head screw (1) and tighten down securely.

Finish off by tensioning the rewind spring.

### Replacing a broken rewind spring

First remove rope rotor (5) and then take spring particles out of starter cover, using pliers if necessary.

The replacement spring is supplied with a wire retainer ready for installation and should be lubricated with a few drops of resin-free oil (e.g. STIHL low temperature lubricant 0781417 1315).

Position rewind spring (6) in the starter cover – the wire retainer is pushed off automatically during this process. Engage outer spring loop on lug in starter cover. If the spring jumps out and uncoils during assembly, it should be

Top: Rewind spring installed with inner spring loop in correct position  
Bottom: Fitting the pawl

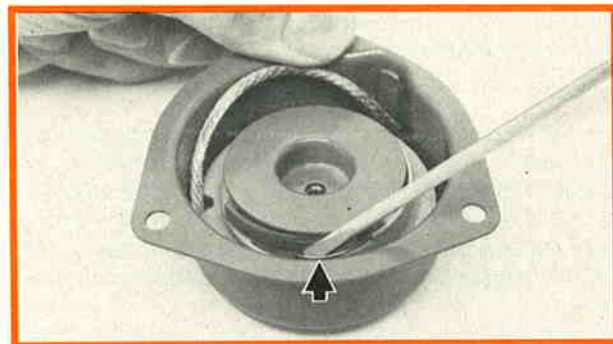
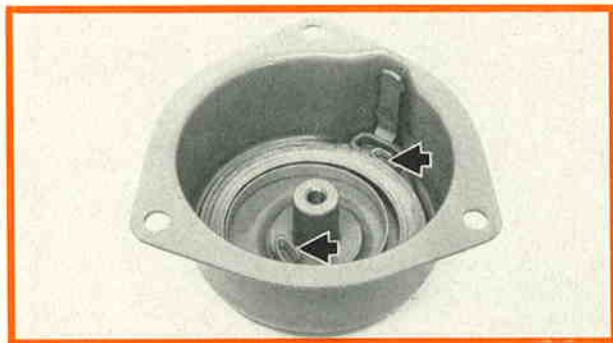

rewound by hand, starting inside and working outward, to a diameter of 55 mm. Then use pointed nose pliers to grip rewind spring about 10 mm from the outer loop and position it in starter cover. Refit rope rotor (5).

### Tensioning the rewind spring

Make a loop in the rope between the recess in the rope rotor (5) and the hole in the starter cover and use loop to rotate rotor two turns clockwise, this tensions the rewind spring (6).

Tensioning the rewind spring

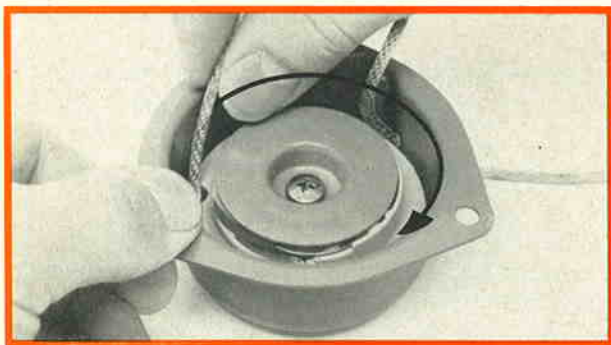

Now pull out rope until it is tight and then allow it do rewind slowly onto the rope rotor.

The rewind spring is correctly tensioned when the starter grip fits firmly against the starter cover without hanging to one side. When the starter rope is pulled out to full length it must still be possible to turn the rope rotor at least  $\frac{1}{2}$  a turn before maximum spring tension is reached. If this is not the case, hold rope rotor firmly and take off one turn of the rope.

**The rewind spring will break prematurely if it is over-tensioned.**

Now refit the starter cover by positioning it on the crank-case so that the starter grip points toward the fuel tank. Note that one mounting flange of the starter cover must be fitted under the bracket for the fuel tank. Then put retainer for throttle cable on one mounting screw and insert and tighten all three screws securely. Check adjustment of throttle cable and correct as necessary.

## Maintenance chart

		before starting work	after finishing work or daily	after each refueling stop	weekly	monthly	if faulty	if damaged	as required	see page:
Complete machine	Visual inspection (condition, leaks)	x		x						
	Clean		x							
Throttle lever, stop switch	Check operation	x		x						15, 16
	Clean					x				
Filter in fuel tank	Replace felt							x		
	Clean					x				
Fuel tank	Clean					x				
Air filter	Clean	x								31
	Replace							x		31
Cylinder fins	Clean					x				
Carburetor	Check idle adjustment – cutting tool must not turn	x		x						30
	Readjuste idle								x	31
Spark plug	Readjust electrode gap (0.6...0.7 mm)						x			
All accessible screws and nuts (not adjusting screws)	Retighten								x	
Spark arrestor screen in muffler	Inspect	x								
	Clean or replace							x		
Steel cutting tools	Visual inspection	x		x						
	Replace							x	x	35
	Sharpen								x	35
Plastic cutting blade	Visual inspection	x		x						34
	Replace							x	x	34

The user of the brushcutter may carry out only the maintenance operations described in this manual. Other repair work may be performed only by an authorized STIHL service shop.

**Warranty claims following a repair will be accepted only if the repair has been carried out by an authorized STIHL servicing dealer using original STIHL parts.**



## Specifications

### Versions available

FS 61 E	Two-handed handlebar
FS 61 RE	Loop handle

### Engine

Single cylinder two-stroke engine	
Displacement:	19.8 cm <sup>3</sup> (1.21 cu.in)
Bore:	30 mm (1.18 in)
Stroke:	28 mm (1.10 in)

### Ignition system

Type:	Electronic (contactless) magneto ignition
Ignition timing:	1.9 mm (0.075 in) before T.D.C. at 6,000 r.p.m.
Spark plug (suppressed):	NGK BMR-6 A
Electrode gap:	0.6-0.7 mm (0.024-0.027 in)
Spark plug thread:	M 14x1.25, 9.5 mm (0.37 in) long

### Fuel system

Carburetor:	All position diaphragm carburetor with integral fuel pump
Air filter:	Felt and foam element
Fuel tank capacity:	0.45 l (0.95 US Pt)
Fuel mixture:	Regular grade gasoline and branded two-stroke engine oil Mix ratio 1:40 with STIHL engine oil, 1:25 with other branded two-stroke engine oils

### Weight

FS 61 E:	less cutting tool	6.1 kg (13.4 lb)
FS 61 RE:	less cutting tool	5.9 kg (13.0 lb)

### Special Accessories for FS 61 E (two-handed handlebar)

STIHL-"Polycut" head	4111 710 2100
Replacement blades (pack of 12)	4111 007 1001
STIHL-"Polymatic 2" head	4112 710 2100*
STIHL-"Polymatic 3" head	4118 710 2100*
STIHL-"Polymatic 4" head	4112 710 2105*
Nylon line (15.2 m/50 ft)	0000 930 2205
STIHL-"Rotocut 220" mounting kit with rider plate	4114 007 1000
STIHL-"Duocut" mounting kit with rider plate	4114 007 1001
STIHL-"Tricut" mounting kit with rider plate	4114 007 1002
Grass cutting blade mounting kit with rider plate	4112 007 1003
Brush knife 250 mounting kit with rider plate	4112 007 1004
Circular saw blade 200 (scratcher tooth)	4112 713 4201
Transport guard for steel cutting tools	4112 790 3900
Safety goggles	

### Special Accessories for FS 61 RE (loop handle)

STIHL-"Polycut" head	4111 710 2100
Replacement blades (pack of 12)	4111 007 1001
STIHL-"Polymatic 2" head	4112 710 2100*
STIHL-"Polymatic 3" head	4118 710 2100*
STIHL-"Polymatic 4" head	4112 710 2105*
Nylon line (15.2 m/50 ft)	0000 930 2205
STIHL-"Rotocut 220" mounting kit with rider plate	4114 007 1000
Safety goggles	

\* not available in all countries